

S  
P  
R  
I  
N  
G  
S  
T  
E  
E  
H



# Extreme

*Built By: Leader Evaporator Co., Inc.*

## **EXTREME HC-4 Reverse Osmosis System**

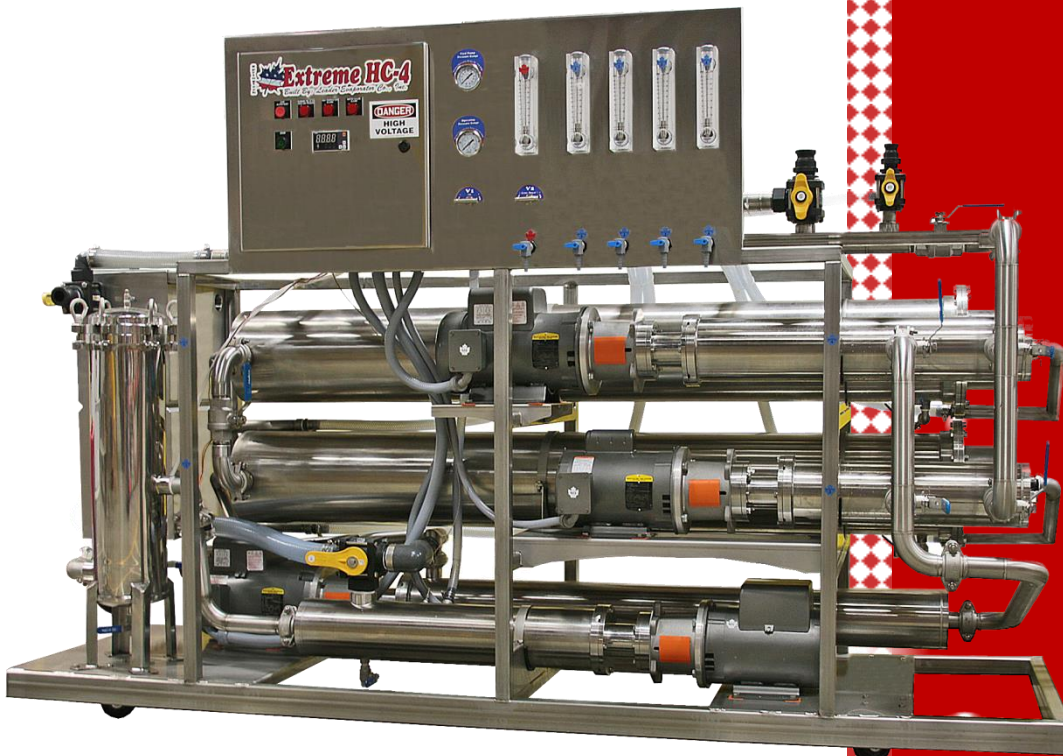

**Leader Evaporator Co., Inc.**

**49 Jonergin Drive**

**Swanton, VT 05488**

**Tel: 802-868-5444**

**[www.leaderevaporator.com](http://www.leaderevaporator.com)**

# TABLE OF CONTENTS

<b>INTRODUCTION .....</b>	<b>4</b>
<b>THEORY OF OPERATION.....</b>	<b>4</b>
<i>Terms.....</i>	4
<i>Description of Membrane.....</i>	5
<b>EQUIPMENT DESCRIPTION.....</b>	<b>6</b>
FRONT VIEW.....	6
REAR VIEW.....	6
FEED PUMP.....	7
PRESSURE PUMP.....	7
RECIRCULATION PUMPS.....	7
PREFILTER ASSEMBLY AND WASH TANK.....	7
CONTROL PANEL.....	8
FLOW METERS.....	8
PRESSURE GAUGES.....	8
SAMPLING PORTS.....	8
V1 AND V2 VALVES.....	9
FLOW CONTROL VALVES.....	9
INCLUDED EQUIPMENT.....	10
OPTIONAL SETUP EQUIPMENT, PARTS AND SUPPLIES.....	11
<b>SETUP .....</b>	<b>12</b>
AREA REQUIRED.....	12
POWER REQUIREMENTS.....	12
<i>Electrical Schematic.....</i>	13
GENERAL CONNECTION LAYOUT.....	13
<i>Simple 3 Tank R/O Layout Diagram.....</i>	13
STRAINER CONNECTIONS.....	14
V6 CONNECTION.....	14
VESSEL, PUMP, PRE FILTER CANISTER AND WASH TANK DRAINS.....	14
V3, V4 AND V19 CONNECTIONS.....	17
<i>V19 – Connection To Drain.....</i>	17
<i>V3 – Connection To Permeate Storage.....</i>	18
<i>V4- Connection To Concentrate Storage.....</i>	18
<b>OPERATION .....</b>	<b>19</b>
STARTUP OF SYSTEM WITH LITTLE OR NO FLUID.....	19
INITIAL SYSTEM CLEANING.....	20
DATA LOGGING.....	20
CYCLES AND TIMING.....	21
PERMEABILITY TEST.....	21
FLOW VALVE INFORMATION.....	24
ADJUSTING V1 AND V2 FOR OPERATIONS.....	25
SAMPLE PORT USE.....	25
CONCENTRATE CYCLE.....	26
REVERSE FLOW CONCENTRATE CYCLE.....	30
DESUGAR CYCLE.....	32

RINSE CYCLE .....	36
WASH CYCLE .....	38
<i>Hot Water Wash</i> .....	38
<i>Alkaline Soap Wash</i> .....	38
<i>Acid Soak</i> .....	39
<b>MAINTENANCE .....</b>	<b>42</b>
PREFILTERS.....	42
MEMBRANE REMOVAL AND INSTALLATION .....	44
<i>Removal</i> .....	44
→ <b>Common Steps for Removal of Locking and Non Locking Style E8 Membranes</b> .....	44
→ <b>Steps for Removal Of Locking Style E8 Membrane</b> .....	45
→ <b>Removal of Non Locking Threaded Rod Style E8 Membranes</b> .....	46
→ <b>Steps for Removal Of Non Locking Clamp Ring Style E8 Membranes</b> .....	47
<i>Installation</i> .....	48
→ <b>Installation of Membranes – Locking and Non Locking Style E8 Membranes</b> .....	48
→ <b>Steps for Installation of Locking Style E8 Membrane</b> .....	48
→ <b>Installation of Non Locking Threaded Rod Style E8 Membranes</b> .....	49
→ <b>Installation of Clamp Ring Style Non-Locking E8 Membranes</b> .....	51
→ <b>Common Steps for Installation of Membranes</b> .....	54
DAILY .....	56
PERIODIC .....	56
END OF SEASON SHUTDOWN AND STORAGE .....	56
BEGINNING OF SEASON STARTUP.....	58
<b>TROUBLESHOOTING CHART .....</b>	<b>60</b>
<b>ATTACHMENT #1 – ELECTRICAL SCHEMATIC – WITH PRESSURE DIFFERENTIAL SWITCH.....</b>	<b>61</b>
<b>ATTACHMENT #2 – OPERATIONS DATA LOGSHEET .....</b>	<b>63</b>
<b>ATTACHMENT #3 – MEMBRANE PERMEABILITY TEST SHEET.....</b>	<b>64</b>
<b>ATTACHMENT #4 – WARRANTY INFORMATION.....</b>	<b>65</b>

## **INTRODUCTION**

A Leader Evaporator Springtech EXTREME Reverse Osmosis system is designed to significantly improve the producer's productivity by generating high sugar percentage sap. Through use of high pressure, the system removes water from the sap resulting in a more concentrated sugar solution entering the evaporator. This in turn shortens the boil time required resulting in fuel and time savings.

Some of the features of the Springtech EXTREME HC-4 are:

- Easy accessibility to pumps and membranes
- Stainless steel frame, membrane housings, pumps and pump housings
- Ability to reverse the flow of the system
- Fast wash cycle
- With reasonable sap – the ability to generate high brix concentrate with a single pass
- Flow meters for the permeate of each membrane and one for the system concentrate

## **THEORY OF OPERATION**

In reverse osmosis, through the use of special semi-permeable membranes and high pressure, water is forced, in a pure form, through the membrane while the concentrated solution remains outside the membrane and is concentrated. For the sugar maker this means water (permeate) is removed from the sap and a sap with a higher sugar level (concentrate) is produced for the evaporation process.

### **Terms**

Semi-permeable Membrane – Unit consisting of multi layers of spacers and membranes

Pre-Filter Unit – Designed to remove suspended solids from the sap incoming to the reverse osmosis system

Feed Pump – The initial pump designed to supply the reverse osmosis unit with sap and maintain pressure in the system

Pressure Pump – The pump designed to provide the pressure needed to force the sap through the reverse osmosis membrane

Pressure Vessel – The containment unit for the semi-permeable membrane

Permeate – Purified water removed from the maple sap during the concentrate cycle

Concentrate – the maple sap having a higher percentage of sugar because water (permeate) has been removed

Permeate Holding Tank – A tank designed to hold a minimum twice the hourly output of the system

Concentrate Cycle – Process during which water is removed from maple sap resulting in Concentrate and Permeate

Reverse Flow Concentrate Cycle – Concentrate cycle in which the flow through the system is reversed allowing more even use of the membranes

De-Sugaring Cycle - Process to reclaim sugars from the membrane during which Permeate is run through the reverse osmosis unit using Concentrate cycle valve settings

Rinse Cycle – Cleaning process of passing stored Permeate through the Reverse Osmosis system and out to drain

Chemical Wash Cycle – Process of chemical washing the membranes by recirculating a solution through the reverse osmosis system. Dependent on requirement, chemical maybe be alkali or acid.

Permeability Test – Test to determine the performance of the membranes against a benchmark

Sap Recirculation Loop – Process of recirculating output from the concentrate cycle to the raw sap tank, increasing the concentration of the sap in the tank

## Description of Membrane

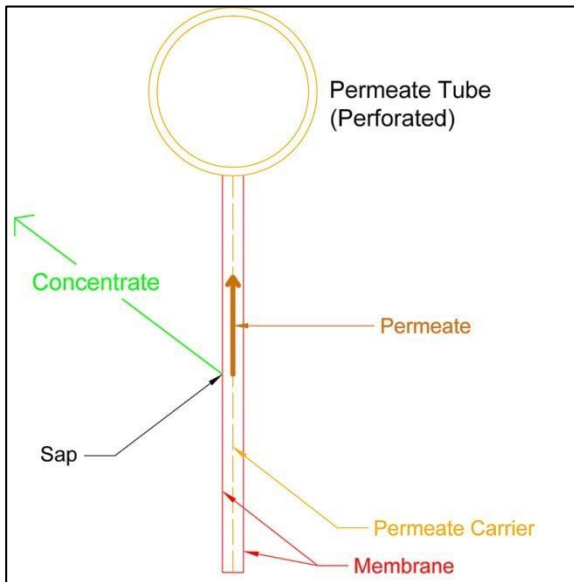

The basic units of the reverse osmosis membrane are described in the *cross section* drawing.

- Attached to the permeate tube is a membrane unit consisting of a permeate carrier between two membranes.
- There are a number of these membrane units attached around the outside of the permeate tube.
- Between each of the membrane units is a spacer through which the sap and concentrate can flow.
- The permeate tube is perforated so the permeate can be collected from the membrane unit.
- At each unit as the sap is pressurized, the permeate can flow through the membrane and be carried to the permeate tube. The concentrate cannot penetrate the membrane and is pushed out the membrane assembly.
- The membrane units are wound around the permeate tube and an outside support structure is placed around the wound assembly.

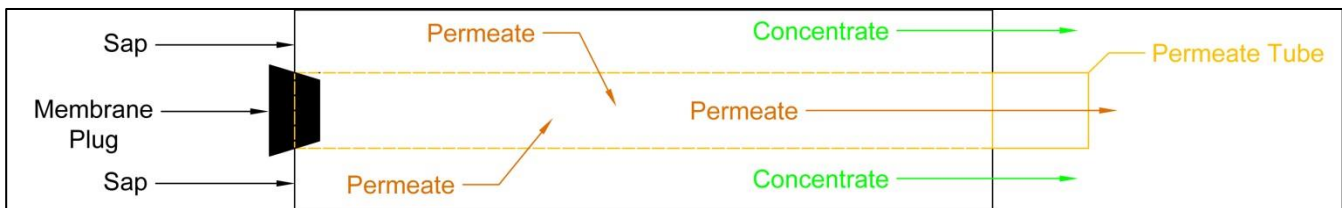

The drawing above represents the flow of liquid through a membrane in the system. The membrane is housed in a pressure vessel (not shown).

## EQUIPMENT DESCRIPTION

The LEADER EVAPORATOR Springtech EXTREME Reverse Osmosis System is designed to offer maximum concentration to cost performance. Through optimizing of pumps and membranes the reverse osmosis systems deliver greater flow potential to the user. The LEADER EVAPORATOR Springtech EXTREME Reverse Osmosis system is designed and built using the same principles of superior quality applied to our evaporators.

The LEADER EVAPORATOR Springtech EXTREME Reverse Osmosis System is covered by a manufacturer's warranty – See ATTACHMENT #4.

### NOTES:

1. Pictures, sketches and drawings presented in this document are not to scale.
2. Directions (right and left) will be as facing the front of the system.

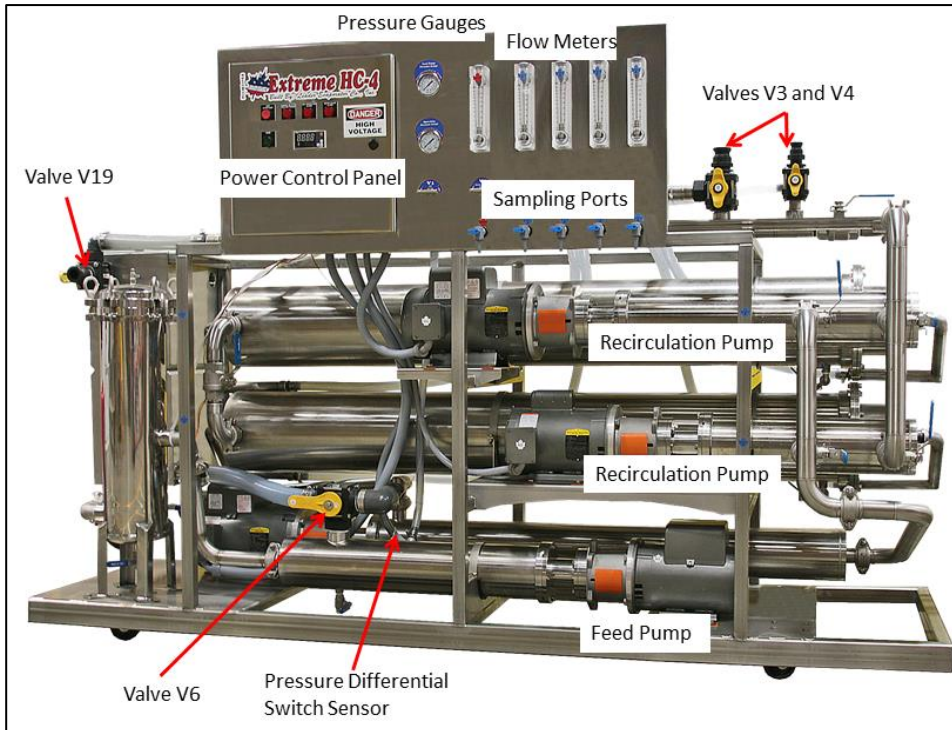

**Front View**

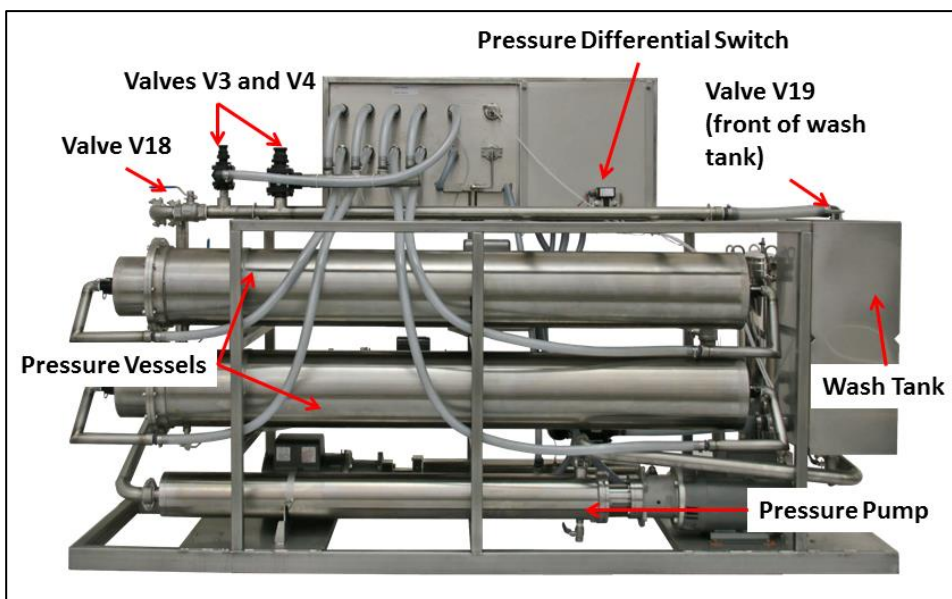

**Rear View**



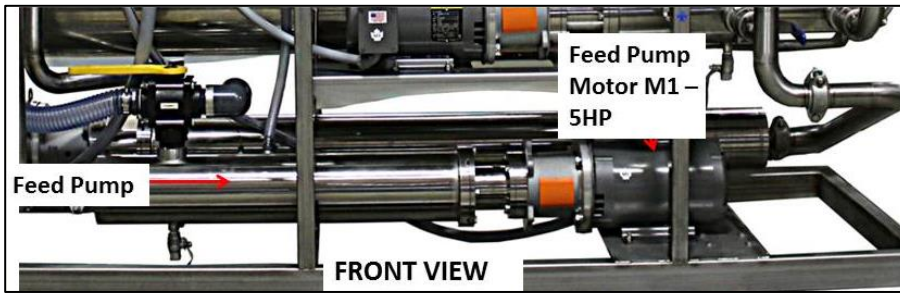

### Feed Pump

Provides liquid to the system and is the first stage of pressurizing the system

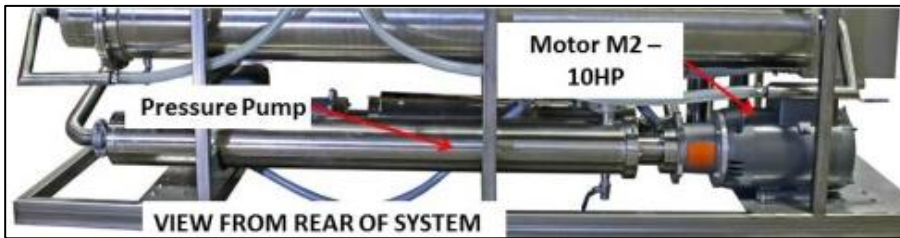

### Pressure Pump

Second stage of pressurizing the system required to process the sap through the membranes

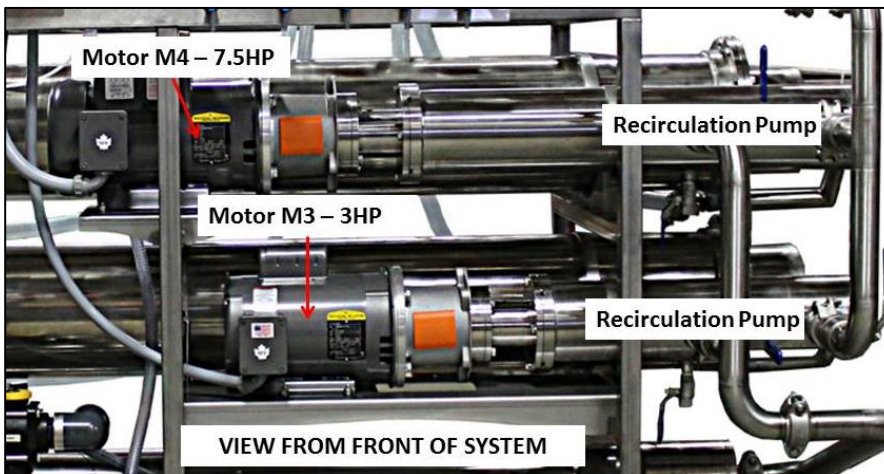

### Recirculation Pumps

Recirculates liquid within the vessel to which they are attached.

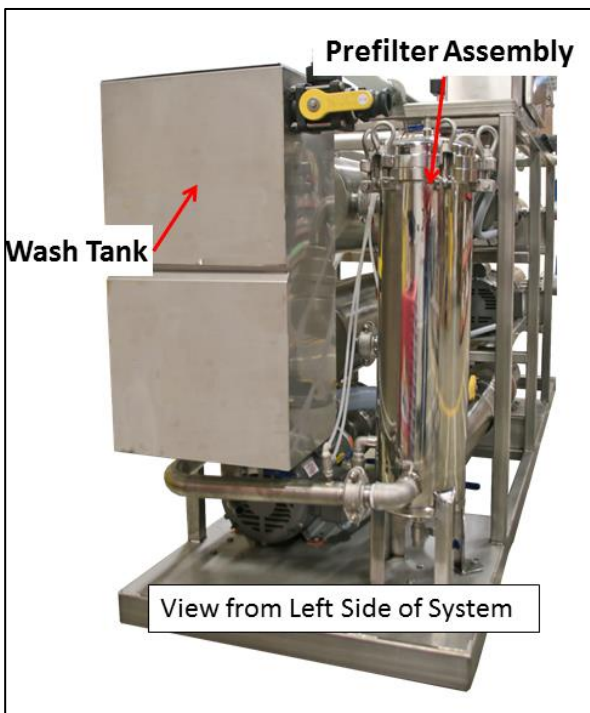

### Prefilter Assembly and Wash Tank

Each prefilter assembly requires (2) - 20" cartridge filters and 1 cartridge filter spacer

Wash tank is used to mix the chemical solution for cleaning the system.

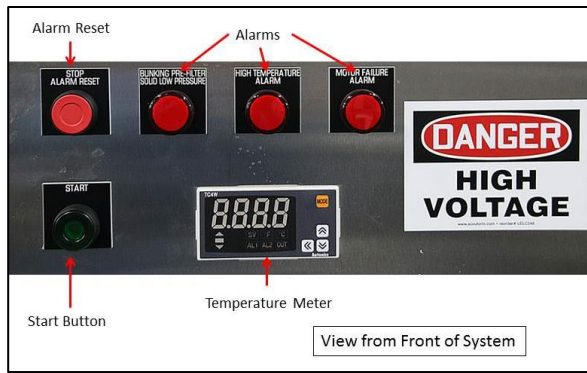

### Control Panel

Start button when pressed starts the system pumps in sequence.

The STOP or ALARM RESET button is a master reset for all the alarms and will stop the machine when pressed.

The Temperature Meter indicates the temperature of the liquid flowing through the system.

*Pressure Alarm* indicates a pressure condition in the system related to the pressure pump requirements. The alarm light may be solid (low pressure) or blinking (prefilter). This alarm can be part of normal operations. The machine will shut down when the indicator light is activated. Note: If the button placard does not have “Blinking Prefilter”, the system does not have the sensor. *High Temperature Alarm* indicates the Wash cycle has completed. This alarm is part of normal operations. The machine will shut down when the alarm light is on. *Motor Failure Alarm* is due a motor contactor tripping. Contact Leader Evaporator.

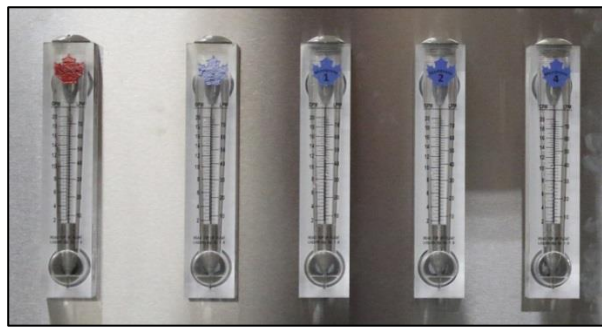

### Flow Meters

The Concentrate Meter indicates the liquid flow from the concentrate side of the pressure vessels in gallons per minute.

The Permeate Meters indicate the permeate flow from each membrane in gallons per minute.



### Pressure Gauges

Feed pump pressure is read after the prefilters.

Membrane pressure is read after the last membrane.

**WARNING: DO NOT ALLOW THE OPERATING PRESSURE TO EXCEED 550 psi.**

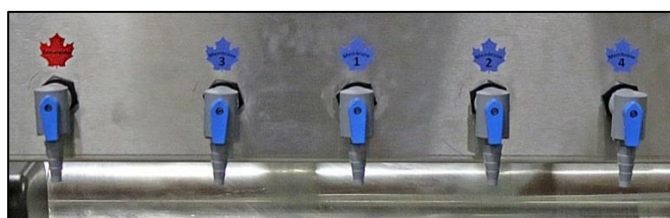

### Sampling Ports

Concentrate port is used to sample the liquid concentrate to determine the sugar percentage.

The Permeate ports are used to sample the permeate from the membranes to determine if they are allowing sugar to pass through.





### V1 and V2 Valves

V1 controls the pressure to the membranes. It is opened ½ way when starting then adjusted to reach the pressure wanted. Close V1 to raise the pressure in the system.

V2 controls the flow from the concentrate side of the membranes. It is opened ½ way when starting then adjusted to the desired concentration level.

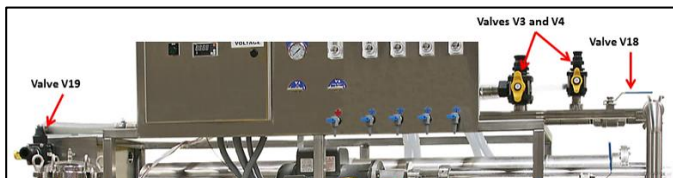

### Flow Control Valves

These valves control the flow of liquid through the system

- V3 – Permeate flow
- V4 – Concentrate flow
- V6 – Feed flow
- V18 – Cleaning or Concentrate flow
- V19 – Drain or Wash Tank

### MEMBRANE FLOW



- V40, V41
- V50, V51

VALVE	TYPE	HANDLE POSITION	LIQUID FROM - TO	HANDLE POSITION	LIQUID FROM - TO
V3	3 - Way	HANDLE POINTING HORIZONTAL	Membranes to Permeate out	HANDLE POINTING VERTICAL	Membranes to Valve V19
V4	3 - Way	HANDLE POINTING VERTICAL UP	Membranes to Concentrate out	HANDLE POINTING VERTICAL DOWN	Membranes to Valve V19
V6	3 - Way	HANDLE POINTING TOWARD INCOMING PIPE	External to Feed Pump	HANDLE POINTING TOWARD WASH TANK PIPE	Wash Tank to Feed Pump
V18	2 - Way	HANDLE POINTING FORWARD	No Flow	HANDLE POINTING RIGHT	Membranes to Valve V19

VALVE	TYPE	HANDLE POSITION	LIQUID FROM - TO	HANDLE POSITION	LIQUID FROM - TO
V19	3 - Way	HANDLE POINTS FORWARD	Membranes to Wash Tank	HANDLE POINTS DOWN	Membranes to Drain
WD	2 - Way	HANDLE POINTING HORIZONTAL	Recirculation to feed pump	HANDLE POINTING VERTICAL	Wash Tank Drain
V41	2 - Way	HANDLE POINTING VERTICAL	No Flow	HANDLE POINTING HORIZONTAL	Liquid from Pressure Pump into Recirculation Pump
V42	2 - Way	HANDLE POINTING VERTICAL	No Flow	HANDLE POINTING HORIZONTAL	Liquid from Pressure Pump into Recirculation Pump
V51	2 - Way	HANDLE POINTING VERTICAL	No Flow	HANDLE POINTING HORIZONTAL	Concentrate from Membranes to Front Panel
V52	2 - Way	HANDLE POINTING VERTICAL	No Flow	HANDLE POINTING HORIZONTAL	Concentrate from Membranes to Front Panel





The Leader Springtech EXTREME Reverse Osmosis system consists of the following parts:

### Included Equipment

ITEM	LEADER ORDER #	DESCRIPTION / PHOTO
Springtech EXTREME HC-4	700048HC	
Springtech EXTREME HC-4 User Manual		
1 – 1/2” Quick Coupler C Qty: 2	<a href="#">47160</a>	

ITEM	LEADER ORDER #	DESCRIPTION / PHOTO
Strainer Y 2” modified with bleeder valve	70141	
Springtech EXTREME HC-4 Quick Start Guide		
1 ” Quick Coupler C Qty: 1	<a href="#">47148</a>	

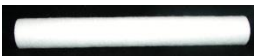
## Optional Setup Equipment, Parts and Supplies

ITEM	LEADER ORDER #	DESCRIPTION / PHOTO
Membrane Preservative, 1 lb.	<a href="#">70001</a>	
Citric Acid, 1 lb.	<a href="#">70008</a>	
20" Cartridge Filter	<a href="#">70012</a>	
Digital Refractometer	61058	
12" Sap Hydrometer	<a href="#">61061</a>	
pH Meter	61060	
Food Grade Grease	<a href="#">55095</a>	

ITEM	LEADER ORDER #	DESCRIPTION / PHOTO
RO Soap 5 Lbs.	69992	
Glycol, 1 gal.	<a href="#">70009</a>	
Cartridge Filter Spacer	70144	
Sap Refractometer	<a href="#">61073</a>	
Long 2" Diameter Test Cup	<a href="#">59006</a>	
pH Meter Replacement Probe	61060P	
Pre-filter O-ring	192	

## SETUP

### NOTES:

- All materials used should be approved for potable water. No copper should be used.
- When installing plumbing for the system, factor in the system may need to be moved for such items as maintenance. It is recommended the connections be made with fittings such as quick disconnects.
- All feed piping to the Springtech Leader Extreme system must be at least as large as the feed on the system itself – 2” minimum is recommended
- All installations must meet applicable governmental regulations.

### Area Required

The space to be used should be capable of preventing the RO system from freezing. Additionally it will need to have adequate ventilation during operations to prevent overheating.

The dimensions of the main system unit are

- Width – 34”
- Length – 103”
- Height – 71”

A minimum of two feet around the system is recommended. You must also be able to obtain an additional 8 feet in length in order to remove membranes and pump assemblies.

The room should have adequate drainage. The walls, ceiling and floor should be easy to clean.

### Power Requirements

The system requires 220V / 1 Phase, 113 amps. All electrical work should be done by a licensed electrician and meet all local codes.

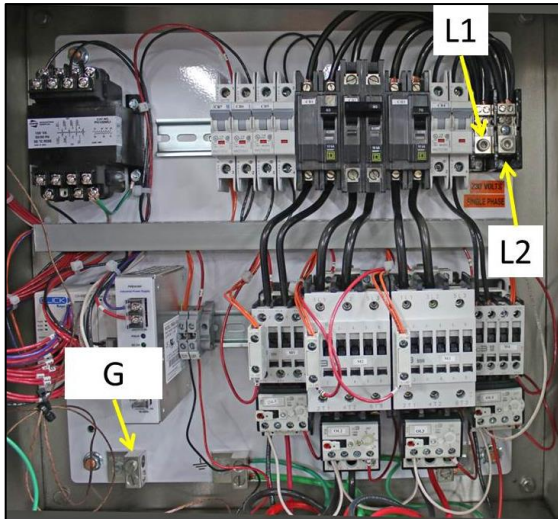

MOTOR ID	MOTOR FUNCTION	SIZE (HP)	NAMEPLATE AMPERAGE
M1	Feed Pump	5	23
M2	Pressure Pump	10	46
M3	Recirculation Pump	7.5	30
M4	Recirculation Pump	3	14

**NOTE:** Any time the control panel is opened, the power should be turned off at the source.



## Electrical Schematic

1. The electrical schematic for the system can be found in [ATTACHMENT #1](#)

## General Connection Layout

The following illustrates a generalized layout for connections with the Springtech EXTREME RO System. The first drawing shows tank connections to the system. The second drawing shows an arrangement of valves to connect the incoming liquid to the system. Dependent on the location, other arrangements are likely. It is beyond the scope of this document to recommend the best layout for all situations. It is recommended you contact your LEADER EVAPORATOR sales person or your local Distributor / Dealer for assistance in deciding the correct tanks and layout for your needs.

## Simple 3 Tank R/O Layout Diagram

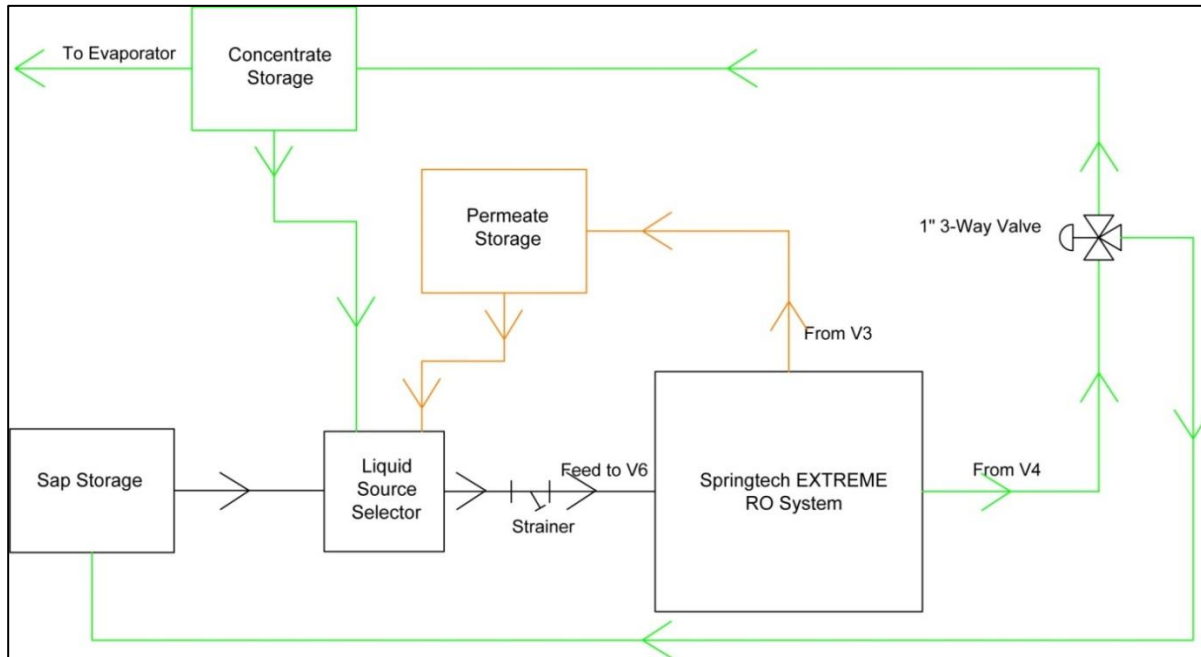

## Liquid Source Selector

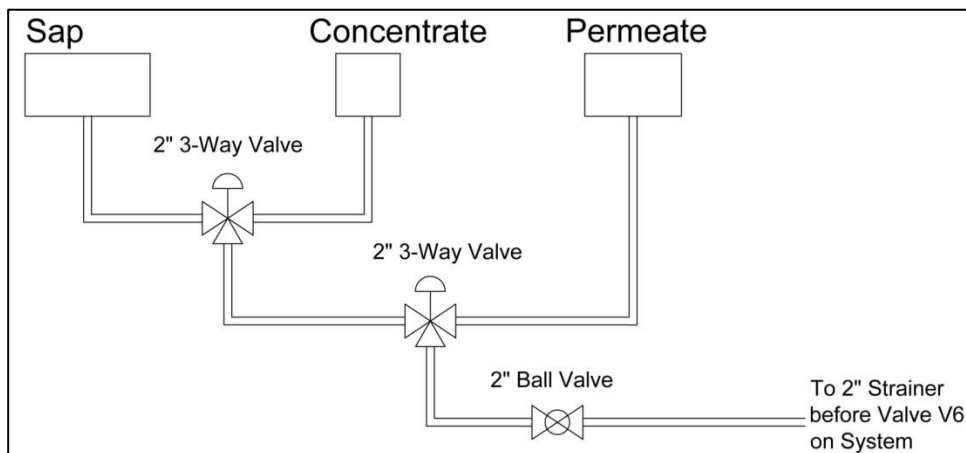

Valves should be in the R/O room for ease of operation. Additional valves and tanks may be required depending upon installation.

## Strainer Connections

Plumbing from the supply tanks is recommended to be a minimum of 2" ID. The input to the strainer will need to be 2". The strainer is not mounted to the system. It will need to be mounted by the user. The connection can be made as follows:

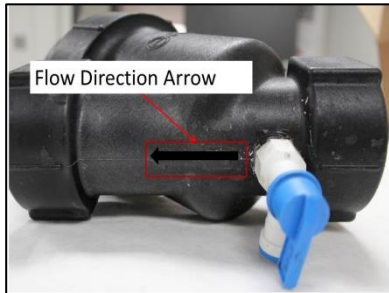

1. Identify the flow direction through the strainer,. There is an arrow on top of the strainer which shows the direction of flow. The input side pushes the liquid through the strainer prior to it going into the system. Additionally, when mounting the strainer, the spigot should be on top as it will need to be opened to bleed air from the system,
2. Install a valve before the Y strainer so the strainer can be removed and cleaned.

## V6 Connection

The V6 valve is to be setup so the connection can be easily disconnected and reconnected as necessary. The following is the recommended connection detail.



1. Teflon tape a 2" F style quick coupler.
2. Thread the F style quick coupler into valve V6. Tighten the coupler. NOTE: Secure valve V6 so as not to break it when tightening the coupler.
3. Obtain a length of 2" food grade hose such as Tiger Flex (Leader Order # 60039) that will connect to the strainer output on the incoming liquid source.
4. Slide a 2" stainless steel band clamp over one end of the hose.
5. Slide the hose onto a 2" C style quick coupler and tighten the clamp over the coupler.
6. Pull the metal latches on the quick coupler out to the sides (perpendicular to the body of the quick coupler) then slide the open end of the coupler over the F style coupler on valve V6.
7. Raise the metal latches on the quick coupler back to the side of the C quick coupler while pressing the couplers together.

## Vessel, Pump, Pre Filter Canister And Wash Tank Drains

Vessel and pump drains are provided with a ½" stainless steel ball valve. Vessels and pumps being drained may contain concentrate. It is recommended the drains be setup to allow collection of the liquid. You will need (items not included);

- 6 – ½" PVC adapters - optionally to allow for 90° connection use combo elbows
- 6 – ½" Stainless Steel band clamps
- 6 pieces of ½" hose long enough to connect to the drain adapter and to reach the collection point

The drains are located:

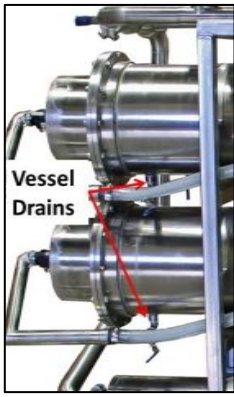

- 1 under each membrane vessel

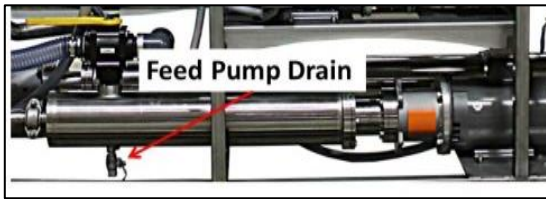

- 1 under the feed pump

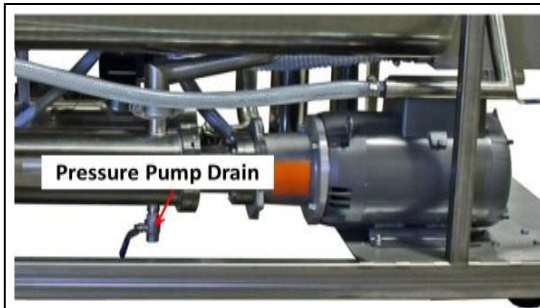

- 1 under the pressure pump

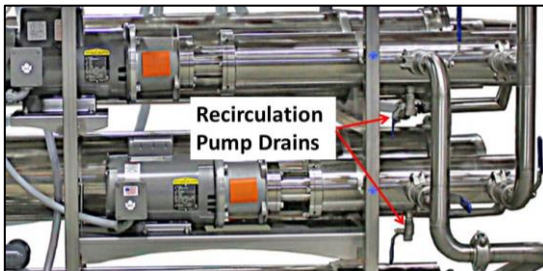

- 1 under each recirculation pump

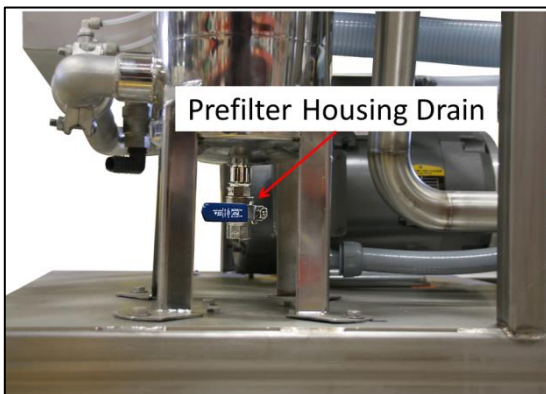

- 1 under the prefilter housing

The wash tank drain is provided with a 1" stainless steel ball valve. To setup the drain you will need (items not included);

- 1 – 1" PVC adapter - optionally to allow for 90° connection use combo elbows
- 1 – 1" Stainless Steel band clamps

The drain is located:

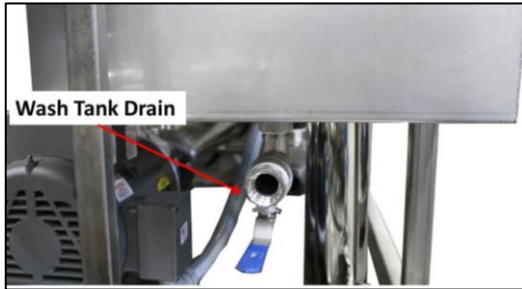

- Under the wash tank

The wash tank is also supplied with a 1 – ½" connection for an overflow drain. The recommended connection is as follows (items not included):

- Install a 2" 90° combo elbow into the wash tank overflow connection and use 2" piping to drain

The drain is located:



Near the top of the wash tank

Install drain connections as follows:



1. Teflon tape the PVC adapter. Optionally if a 90° connection is preferred, Teflon tape a combo elbow and use it in place of the straight adapters where desired.







2. Thread the PVC adapter into the stainless steel ball valve.



3. Cut the hose to length (to reach from the ball valve to the point where you will be collecting the liquid). Place a stainless steel band clamp over one end of the hose. Slide the hose onto the PVC adapter. Position the stainless steel band clamp over the hose on the adapter and tighten the band clamp.

### **V3, V4 and V19 Connections**

V3, V4 and V19 valves are to be setup so the connections can be easily disconnected and reconnected as necessary. The following is the recommended connection detail.

In order to assemble the connections you will need (braided hose and clamps sold separately);

- 3 – C style Quick Couplers (two 1 – ½”, one 1”) - supplied
- 3 (minimum) stainless steel band clamps – (two (minimum) 1 – ½”, one (minimum) 1”)
- 1” ID braided food grade hose with length to make the connection to the Concentrate tank. 1 – ½” ID braided food grade hose with length to make the connection to the Permeate tank. The connection to the drain can be made with flexible hose.

### **V19 – Connection To Drain**



1. Cut 1 – ½” ID flexible hose to reach from the valve V19 to the drain connection.
2. Place at least one 1 – ½” stainless steel band clamp over one end of the hose.
3. Slide the hose onto the 1 – ½” C style quick coupler.
4. Position the stainless steel band clamp(s) over the hose on the coupler and tighten the band clamp(s).
5. Secure the other end of the hose to the drain connection.
6. Connect the quick couplers by opening the latches on the C style coupler (position the metal latch arms out perpendicular to the body of the coupler) then sliding the C coupler onto the F coupler. Pull the metal latch arms back down to the sides of the C coupler.

### V3 - Connection To Permeate Storage



1. Cut 1 – ½” ID food grade braided hose to length – from valve V3 to the fill connection for the permeate tank.
2. Place at least one 1 – ½” stainless steel band clamp over one end of the hose.
3. Slide the hose onto a 1 – ½” C style quick coupler.
4. Position the stainless steel band clamp(s) over the hose on the adapter and tighten the band clamp(s).
5. Secure the other end of the hose to the permeate tank fill connection.
6. Connect the quick couplers by opening the latch on the C style coupler (position the metal latch arms out perpendicular to the body of the coupler) then sliding the C coupler onto the F coupler. Pull the metal latch arms back up to the sides of the C coupler.

### V4- Connection To Concentrate Storage



1. Cut 1” ID food grade braided hose from valve V4 to the fill connection for the concentrate tank.
2. Place at least one 1” stainless steel band clamp over one end of the hose.
3. Slide the hose onto a 1” C style quick coupler.
4. Position the stainless steel band clamp(s) over the hose on the adapter and tighten the band clamp(s).
5. Secure the other end of the hose to the concentrate tank fill connection.
6. Connect the quick couplers by opening the latch on the C style coupler (position the metal latch arms out perpendicular to the body of the coupler) then sliding the C coupler onto the F coupler. Pull the metal latch arms back up to the sides of the C coupler.

## OPERATION

When starting the Reverse Osmosis unit there is a sequence in which the pumps will activate. Pressing the START button will first activate the feed pump. In normal operations within 30 seconds the pressure pump will start followed by one recirculation pump and finishing with the second recirculation pump.

During any cycle if permeate is not available, use non chlorinated well or spring water.

### Startup of System with Little or No Fluid

1. Set the system valves for a rinse cycle (see page 36).
2. Turn off the power to the system at the source.
3. Open the control box by turning the latches on the right side of the panel then opening the door carefully to the left.
4. Turn off the pressure and recirculation pump breakers:

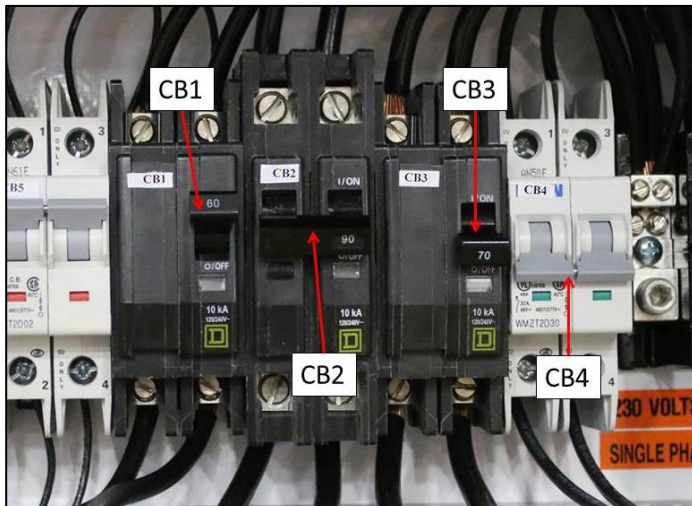

BREAKER ID	CIRCUIT	START POSITION
CB1	Feed Pump	ON
CB2	Pressure Pump	OFF
CB3	Recirculation Pump	OFF
CB4	Recirculation Pump	OFF

5. Close the control box cover and turn the latches to fasten.
6. Turn on the power to the system at the source.
7. Ensure your source valves (water or permeate) are open to feed the system.
8. Press the START button to start the feed pump.
9. Run the feed pump until most of the bubbles are gone from the flow meters located on the front of the system. This will take 3 to 4 minutes. Not all the bubbles can be removed.
10. Press the STOP button to stop the feed pump.
11. Turn off the power to the system at the source.
12. Open the control box and position breakers CB1, CB2, CB3 and CB4 to the ON position.
13. Close the control box cover and refasten the latches.
14. Turn on the power to the system at the source.
15. Proceed to the instructions for the Initial System Cleaning.

## Initial System Cleaning

To prepare the system after setup;

NOTE: IF the system has not been filled with fluid, follow the instruction in the section “Startup of System with Little or No Fluid”.

1. Put approximately 2400 US gallons of non-chlorinated well or spring water into a clean permeate storage tank.
2. Set the valves for and run a rinse cycle (see page 36) using a minimum 1200 US gallons of water from the permeate tank. While this cycle is running check all fittings, piping, connections and hoses for leaks. Repair as necessary.
3. At the end of the rinse cycle change the position of valve V19 so the liquid flow is directed to the wash tank. When the wash tank is approximately  $\frac{2}{3}$  full, return V19 to the drain position.
4. Mix alkaline R/O soap with the liquid in the wash tank until the required pH is reached. To determine the required pH, refer to the Machine Serial Number Data Sheet that initially accompanied the system. NOTE: If the membrane is changed, reference the data sheet accompanying the new membrane.
5. Set the valves for and run an alkaline wash cycle (see page 38) allowing the system to run until the automatic temperature shutdown at 118°F.
6. Set the valves for and run a rinse cycle (see page 36) using a minimum 1200 US gallons of water from the permeate tank.
7. Run the benchmark permeability test (see page 21).

## Data Logging

Data on the operation of the system should be recorded and kept. See ATTACHMENT #2 for the data sheet format.

The following data is recorded:

- Date – date the information is collected
- Activity – Concentration cycle (enter a C) or Test (enter a T)
- Sap % - the sugar concentration of the raw sap
- Concentrate % - the sugar concentration of the concentrate from the system – test results from the concentrate port
- Permeate 1 Flow – gallons per minute of permeate from membrane 1 – reading from the top of the stainless steel float in the permeate flow meter
- Permeate 2 Flow – gallons per minute of permeate from membrane 2 – reading from the top of the stainless steel float in the permeate flow meter
- Permeate 3 Flow – gallons per minute of permeate from membrane 3 – reading from the top of the stainless steel float in the permeate flow meter
- Permeate 4 Flow – gallons per minute of permeate from membrane 4 – reading from the top of the stainless steel float in the permeate flow meter
- Concentrate Flow – gallons per minute of concentration from the system – reading from the top of the stainless steel float in the concentrate flow meter
- Temperature – reading from temperature gauge on the control panel of the system (°F)
- Feed Pressure – reading from the pressure gauge on the control panel of the system (psi)
- Membrane Pressure – reading from the pressure gauge on the control panel of the system (psi)
- Water Removal % - percent of water removed from incoming sap – calculated as follows
  - PERMEATE FLOW – Add all Permeate Flows together
  - TOTAL FLOW - Add all Permeate Flows and Concentrate Flow together
  - Divide PERMEATE FLOW by TOTAL FLOW and multiply the result by 100
  - Record this number as the Water Removal %



- GPH Processed – gallons per hour being processed by the system- calculated as follows
  - TOTAL FLOW – Add all Permeate Flows and Concentrate Flow together
  - Multiply Total Flow by 60 and record the resulting number as the GPH Processed

## Cycles and Timing

The Springtech EXTREME HC-4 has 5 defined cycles; Concentrate / Reverse Concentrate, Desugar, Rinse and Wash. The following table outlines recommended intervals

CYCLE	INTERVAL
Concentrate	Run 1 to 6 hours dependent on sap quality
Reverse Concentrate	Run 1 to 6 hours dependent on sap quality
Desugar	Run at the end of every Concentrate cycle OR at the end of each day whichever comes first
Rinse	Run after the Desugar cycle
Wash	Chemical wash after a rinse. A chemical wash should be run after 6 hours of concentrating OR at the end of every day – whichever comes first. NOTE: If only a few hundred gallons of sap was run and the machine is to be cleaned, run a hot water wash

The following cycles always need to be run in sequence when used:

- Desugar
- Desugar - Alkaline Soap Wash (also called Alkaline Soap Wash cycle)
- Desugar - Alkaline Soap Wash - Acid Soak - Alkaline Soap Wash (also called Chemical Wash cycle)

## Permeability Test

A permeability test determines the permeate flow rate of a membrane. When a membrane is new it will usually have a permeate flow rate above 10 GPM when tested. The first or second use will condition the membrane which reduces the permeate flow rate. Typically due to the construction of the membrane the flow will be reduced by 10% to 15% resulting in a permeate flow rate testing between 9 GPM and 10 GPM. The membrane flow rate should be tested after the conditioning and this flow rate will be the benchmark for comparison in future testing.

The permeability test is used to monitor the performance of the system. It is based on comparing the results of a benchmark test taken when the system is conditioned or at the end of the previous season after the final cleaning is completed. The permeate flow rate is the basis for the results of the test. Due to the inability to completely clean the membrane, membrane flow rate reductions of up to 10% to 15% as measured season to season are possible. When flow rates have reduced to an unacceptable working level, contact Leader Evaporator for assistance.

### LOGGING DATA FOR THE PERMEABILITY TEST

To log data for the Permeability test, use the Membrane Permeability Test Sheet. A copy is attached (see Attachment #3) from which copies can be made. Use the sheet as follows:

1. A separate sheet is to be used for EACH membrane in the system ex. a model HC-4 requires 4 Test Sheets as there are 4 membranes in the system.
2. Fill in your name in the field labelled “Customer Name”.
3. The Model Number field will have the system prefilled.
4. Find the Serial Number of the system on the Machine Serial Number Data Sheet and write it in the field labelled “Machine Serial #”.
5. In the field labelled “Membrane Location”, fill in the location of the membrane to be tracked. To determine the membrane location:
  - a. Membranes on the right side of the system are even numbered.

- b. Membranes on the left side of the system are odd numbered.
- c. The largest numbered membrane is on the top of each side for example a 6 membrane system will have membrane 6 on the top right side and membrane 5 on the top left side.
- d. The membranes are numbered in descending order.

NOTE: Membrane locations are also specified on the Machine Serial Number Data Sheet.

- 6. Find the membrane manufacturer information on the Machine Serial Number Data Sheet (or on the Membrane Test Sheet) and write it into the field labelled "Membrane Manufacturer".
- 7. Find the membrane serial number, on the Machine Serial Number Data Sheet, for the specific membrane being tracked and write it into the field labelled "Membrane Serial #".
- 8. After the initial membrane conditioning or after the final end of season cleaning, perform a permeability test. For each membrane, record the flow rate measured for that membrane in the Benchmark Flow Rate column. This number can be filled in the Benchmark Flow Rate field for all subsequent tests until a new Benchmark test is performed.

Performing the permeability test:

- 1. Perform a rinse (see page 36) then fill the wash tank  $\frac{2}{3}$  full of permeate by moving valve V19 to the horizontal left position.
- 2. Set the valves in the wash cycle position (see page 38).
- 3. Close valve V18.
- 4. Run the system until the temperature reaches 55°F.
- 5. Adjust the membrane pressure to 200 psi using valves V1 and V2. Valve V18 may need to be opened slightly. NOTE: If the starting temperature is higher than 55°F, the same results can be obtained at 70°F and 150psi operating pressure.
- 6. Record the permeate flow onto the Membrane Permeability Test Sheet in the Measured Flow Rate field, if not performing a Benchmark Flow Rate test.

A permeability test should be performed after each wash cycle. The test is performed as described above for steps 2 through 6. Compare the flow rate obtained in the test with previous benchmark rates. If the measured difference (see the calculation below) is 15% or more then further cleaning will be necessary. See the flow chart on page 23.

To calculate the difference to the benchmark, do the following calculation:

- 1. Subtract the measured flow rate from the benchmark flow rate.
- 2. Take the result and divide it by the benchmark flow rate.
- 3. Multiply the answer by 100 and record the result in the Measured Difference field on the Membrane Permeability Test Sheet.

$$\left( \frac{(\text{Benchmark Flow Rate} - \text{Measured Flow Rate})}{\text{Benchmark Flow Rate}} \right) \times 100 = \text{Measured Difference (\%)}$$

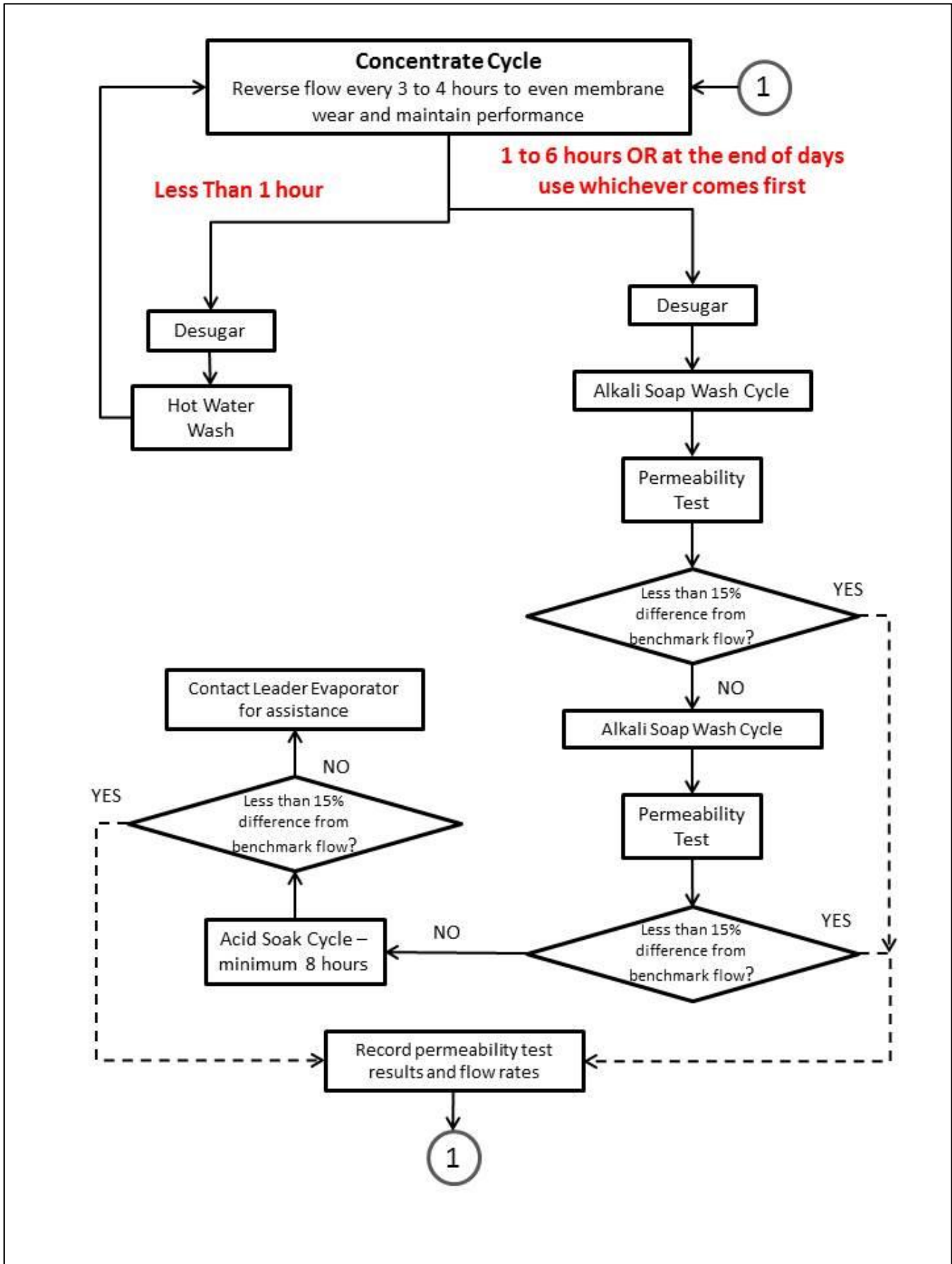

## Flow Valve Information

The following is a table illustrating the type of valve being used and where fluid flows when the valves are in certain positions. NOTE: Flow as stated only occurs when all valves are set for the proper cycles.

VALVE	TYPE	HANDLE POSITION	LIQUID FROM - TO	HANDLE POSITION	LIQUID FROM-TO
V3	3 - Way	HANDLE POINTING HORIZONTAL	Membranes to Permeate out	HANDLE POINTING VERTICAL	Membranes to Valve V19
V4	3 - Way	HANDLE POINTING VERTICAL UP	Membranes to Concentrate out	HANDLE POINTING VERTICAL DOWN	Membranes to Valve V19
V6	3 - Way	HANDLE POINTING TOWARD INCOMING PIPE	External to Feed Pump	HANDLE POINTING TOWARD WASH TANK PIPE	Wash Tank to Feed Pump
V18	2 - Way	HANDLE POINTING FORWARD	No Flow	HANDLE POINTING RIGHT	Membranes to Valve V19
V19	3 - Way	HANDLE POINTING FORWARD	Membranes to Wash Tank	HANDLE POINTING DOWN	Membranes to Drain
WD	2 - Way	HANDLE POINTING HORIZONTAL	Recirculation to feed pump	HANDLE POINTING VERTICAL	Wash Tank Drain
V41	2 - Way	HANDLE POINTING VERTICAL	No Flow	HANDLE POINTING HORIZONTAL	Liquid from Pressure Pump into Recirculation Pump
V42	2 - Way	HANDLE POINTING VERTICAL	No Flow	HANDLE POINTING HORIZONTAL	Liquid from Pressure Pump into Recirculation Pump
V51	2 - Way	HANDLE POINTING VERTICAL	No Flow	HANDLE POINTING HORIZONTAL	Concentrate from Membranes to Front Panel
V52	2 - Way	HANDLE POINTING VERTICAL	No Flow	HANDLE POINTING HORIZONTAL	Concentrate from Membranes to Front Panel

The following is a summary table of the system cycles and the related valve settings for the cycle specified. Detail on the cycle settings is in the sections that follow.

CYCLE	Concentrate	Reverse Concentrate	Desugar	Rinse	Wash
V1	Open ½ way then adjust	Open ½ way then adjust	Open ½ way then adjust	Open Fully	Open Fully
V2	Open minimum ½ way then adjust	Open minimum ½ way then adjust	Open minimum ½ way then adjust	Open Fully	Open Fully
V3	Handle Points Horizontal	Handle Points Horizontal	Handle Points Horizontal	Handle Points Vertical	Handle Points Vertical
V4	Handle Points Vertical Up	Handle Points Vertical Up	Handle Points Vertical Up	Handle Points Vertical Down	Handle Points Vertical Down
V6	Handle Points Toward Incoming Pipe (Sap)	Handle Points Toward Incoming Pipe (Sap)	Handle Points Toward Incoming Pipe (Permeate)	Handle Points Toward Incoming Pipe (Permeate)	Handle Points Toward Wash Tank Pipe
V18	Handle Points Forward	Handle Points Forward	Handle Points Forward	Handle Points Right	Handle Points Right
V19	Handle Points Forward	Handle Points Forward	Handle Points Forward	Handle Points Down	Handle Points Forward
Drains	Closed	Closed	Closed	Closed	Closed
BP	Handle Points Vertical	Handle Points Vertical	Handle Points Vertical	Handle Points Vertical	Handle Points Vertical
WD	Handle Points Horizontal (closed)	Handle Points Horizontal (closed)	Handle Points Horizontal (closed)	Handle Points Horizontal (closed)	Handle Points Horizontal (closed) except Vertical to drain wash tank
V41	Handle Points Horizontal	Handle Points Vertical	Handle Points Horizontal	Handle Points Horizontal	Handle Points Horizontal
V42	Handle Points Vertical	Handle Points Horizontal	Handle Points Vertical	Handle Points Vertical	Handle Points Vertical
V51	Handle Points Vertical	Handle Points Horizontal	Handle Points Vertical	Handle Points Vertical	Handle Points Vertical
V52	Handle Points Horizontal	Handle Points Vertical	Handle Points Horizontal	Handle Points Horizontal	Handle Points Horizontal

NOTE: During the Rinse cycle, if the machine shuts down due to low pressure and the feed line has been bled or if during the Wash Cycle the machine shuts down due to low pressure, check the prefilters. If the prefilters are dirty, replace and retry the rinse/wash cycle. If the prefilters appear clean or are new and the problem continues, partially close valve V18 until an operating pressure of 50 – 80 psi is reached and run the remainder of the cycle.

### Adjusting V1 and V2 for Operations

The maximum pressure is 550 psi with a recommended level of 400 to 500 psi.

V2 is adjusted for concentration output by flow or % sugar.

There are two methods of determining how to set the V1 and V2 valves.

- Turn V1 to a minimum pressure and turn V2 until the desired concentration is obtained. Adjust V1 until the pressure desired is reached. Readjust V2 until the concentration desired is reached.
- Volume Preferred – Turn V2 to a minimum and Turn V1 until the desired flow is reached. Adjust V2 until the concentration desired is reached. Readjust V1 until the desired flow is reached.

### Sample Port Use

When using the concentrate sample port, run approximately 1 test cup of concentrate through in order to purge the lines. Pour that cup back into the raw sap tank. Draw a second cup and sample.

The permeate sampling ports should be purged as done with the concentrate sample port. The permeate through these ports should be sampled once per day.



## Concentrate Cycle

In this cycle the system inputs sap or pre-concentrated sap and cycles it through the membranes resulting in a concentrated liquid (concentrate) and the water being removed (permeate).

There are two output options within the Concentrate Cycle. The first is to direct the concentrate to the concentrate tank. The second is to direct the concentrate to the sap tank – this is called the Sap Recirculation Loop. Valves are required between valve V4 and the concentrate tank allowing the option for concentrate to be directed to the sap tank (valves sold separately).

## Standard Concentrate Output

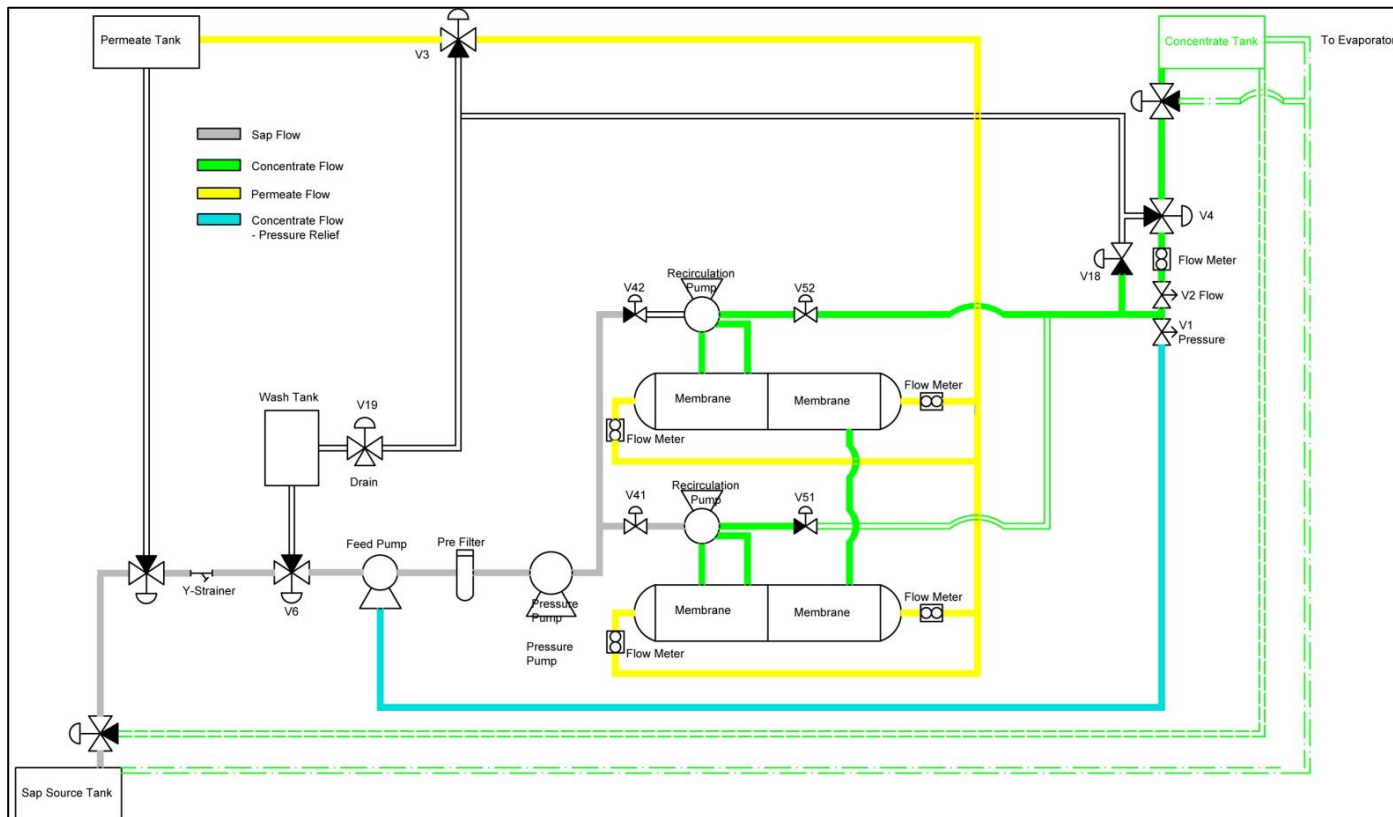

## Sap Recirculation Loop

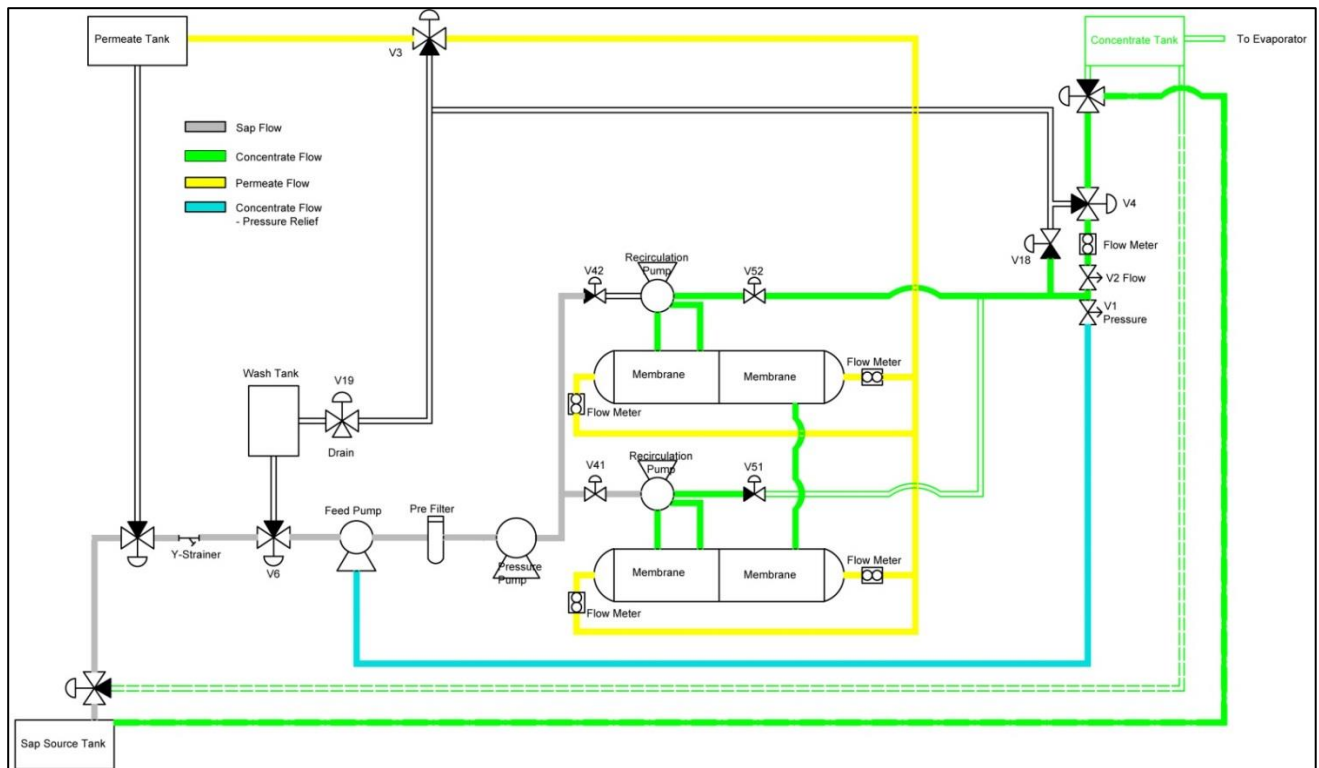

Concentrate Cycle Valve Settings – also available on the Quick Start Guide

1. Position the valves as follows:



V1 – Open ½ way to start then adjust to the desired maximum pressure. (Do NOT exceed 550 psi)

V2 – Open a minimum of ½ way to start then adjust to the desired concentration level or flow.



WD – Horizontal Left, valve is closed

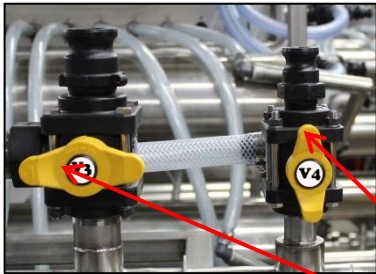

V3 – The flow indicator should be Horizontal Left

V4 – The flow indicator should be Vertical Up



V18 – Horizontal Forward



V19 - With V3 and V4 in the concentrate setting  
V19 should have no flow. Direct V19 to the  
wash tank as a precaution. Horizontal  
Forward



V6 – The flow indicator should be toward the pipe incoming  
from the exterior source selector. Input from source  
selector should be from the raw sap (or previously  
concentrated sap).



- V41 – Horizontal Left (Open)
- V42 – Vertical Up (Closed)
- V51 – Vertical Up (Closed)
- V52 – Horizontal Left (Open)

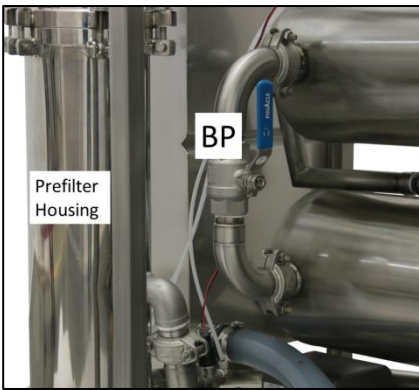

- BP (Membrane Bypass) – Vertical (Open)

2. Press the START button on the control panel. Within 30 seconds all pumps should start.
3. If the system does not continue to run due to a LOW PRESSURE ALARM;
  - a. Light is SOLID - Repeat Step 2 up to 2 additional times. The STOP ALARM RESET button will need to be pressed after each time.
  - b. Light is BLINKING – Press the STOP button to reset the alarm. Check the prefilters, changing as necessary. Repeat Step 2.
4. If the system does not start on the third try, bleed the system. To bleed the system, open the valve on the top of the strainer (installed before valve V6) until all the air is released from the system. Close the bleed valve.
5. When the machine has started, adjust V1 and V2 to produce the desired conditions.

## Reverse Flow Concentrate Cycle

This cycle allows for reversing the flow in the system in order to extend the time between membrane cleanings.

### Reverse Flow Concentrate Output

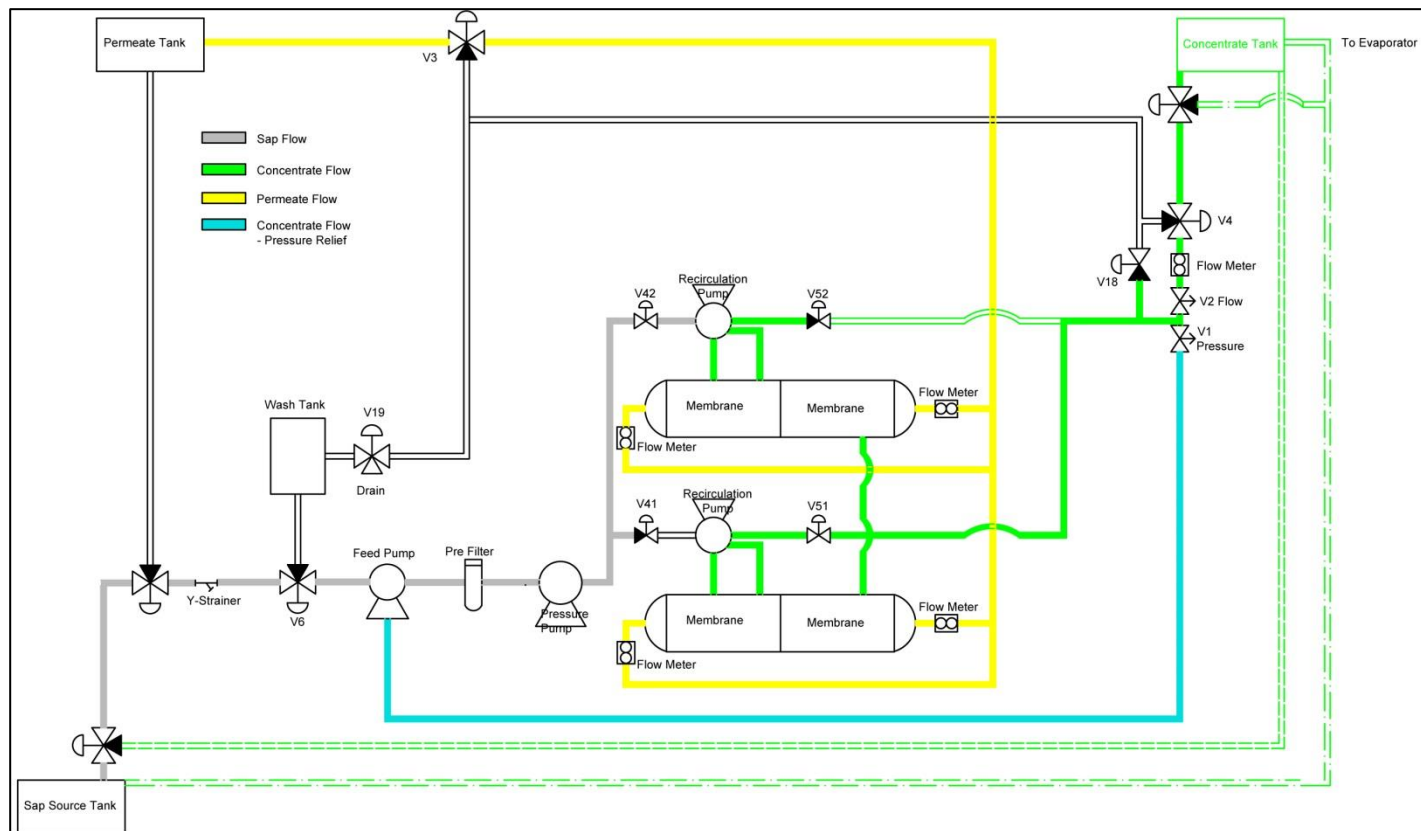

NOTE: Flow can be changed without stopping the system if the sequence below is followed:

1. Change V51 to Horizontal (Open)
2. Change V42 to Horizontal (Open)
3. Change V52 to Vertical (Closed)
4. Change V41 to Vertical (Closed)

Reverse Flow Concentrate Cycle Valve Settings – also available on the Quick Start Guide

1. Position the valves as follows:



V1 – Open ½ way to start then adjust to the desired maximum pressure. (Do NOT exceed 550 psi)

V2 – Open a minimum of ½ way to start then adjust to the desired concentration level or flow.





WD – Horizontal Left, valve is closed

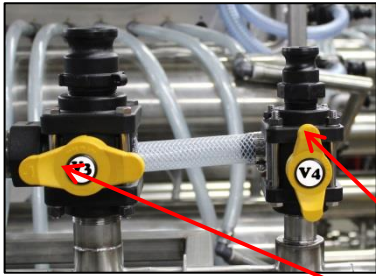

V3 – The flow indicator should be Horizontal Left

V4 – The flow indicator should be Vertical Up



V18 – Horizontal Forward



V19 - With V3 and V4 in the concentrate setting V19 should have no flow. Direct V19 to the wash tank as a precaution. Horizontal Forward



V6 – The flow indicator should be toward the pipe incoming from the exterior source selector. Input from source selector should be from the raw sap (or previously concentrated sap).



- V41 – Vertical Up (Closed)
- V42 – Horizontal Left (Open)
- V51 –Horizontal Left (Open)
- V52 – Vertical Up (Closed)

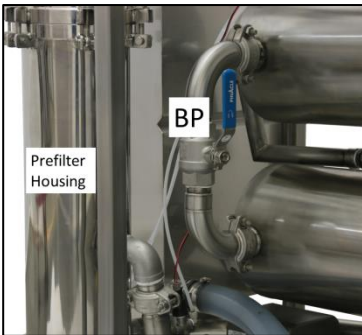

BP (Membrane Bypass) – Vertical (Open)

1. Press the START button on the control panel. Within 30 seconds all pumps should start.
2. If the system does not continue to run due to a LOW PRESSURE ALARM;
  - a. Light is SOLID - Repeat Step 2 up to 2 additional times. The STOP ALARM RESET button will need to be pressed after each time.
  - b. Light is BLINKING – Press the STOP button to reset the alarm. Check the prefilters, changing as necessary. Repeat Step 2.
3. If the system does not start on the third try, bleed the system. To bleed the system, open the valve on the top of the strainer (installed before valve V6) until all the air is released from the system. Close the bleed valve.
4. When the machine has started, adjust V1 and V2 to produce the desired conditions.

## Desugar Cycle

In this cycle the permeate is run in a concentrate cycle to flush accumulated sugar from the membranes. Dependent on the operation, the Desugar process may be done in one of the following ways:

- Flushing liquid for the full cycle is run to the concentrate tank
- Flushing liquid for the full cycle is run to the sap tank
- Flushing liquid for the part of the cycle with the highest concentration of sugar is run to the concentrate tank then the remainder is run to the sap tank

**Flush Liquid Running To Concentrate Tank (first part of Desugar with higher sugar % being rinsed out)**

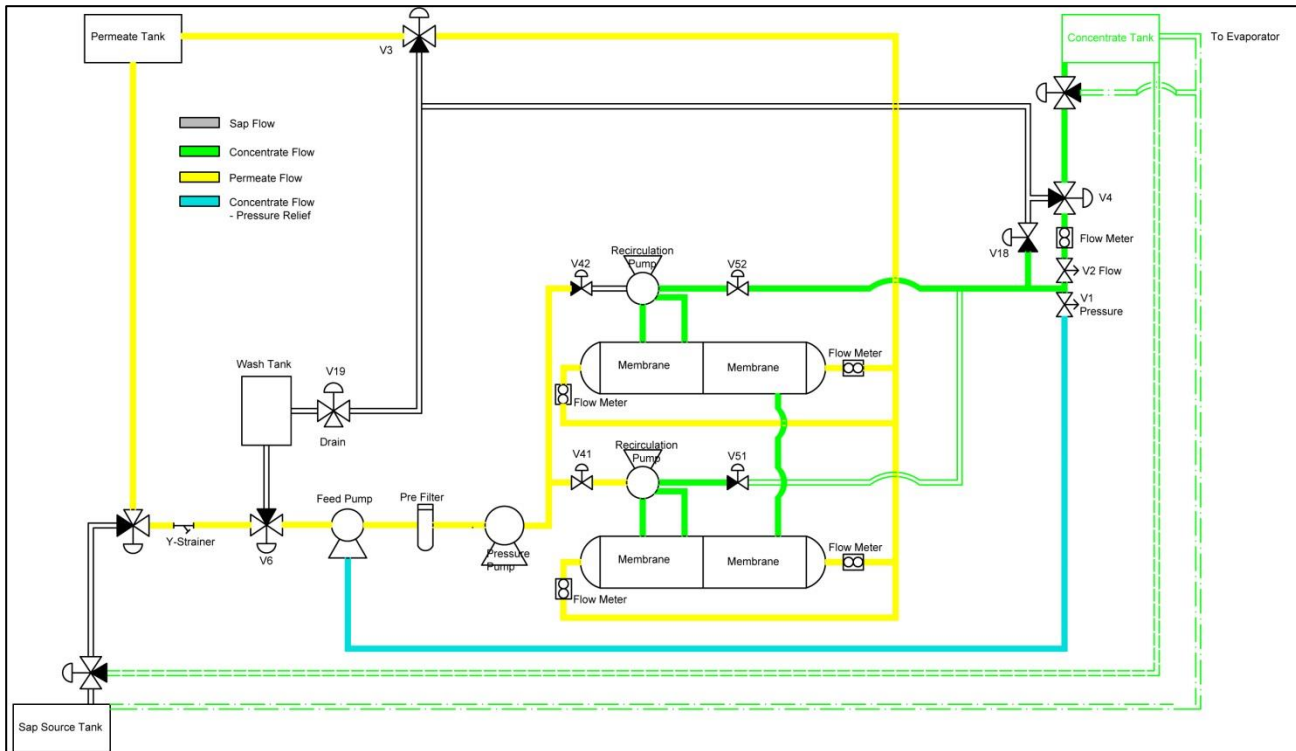

**Flush Liquid Running To Sap Tank (later part of Desugar with lower sugar % being rinsed out)**

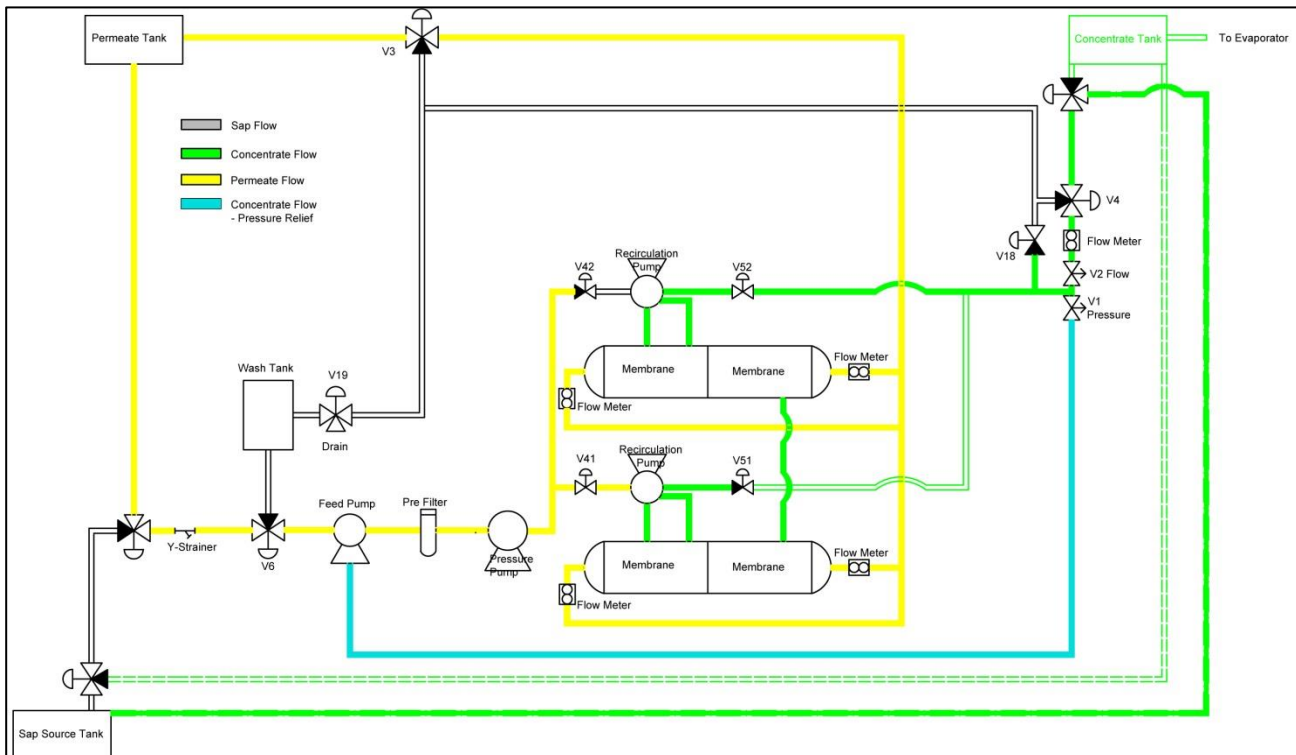

Desugar Cycle Valve Settings – also available on the Quick Start Guide

1. Position the valves as follows:



V1 – Leave valve where it was set during the concentration cycle.

V2 – Leave valve where it was set during the concentration cycle.

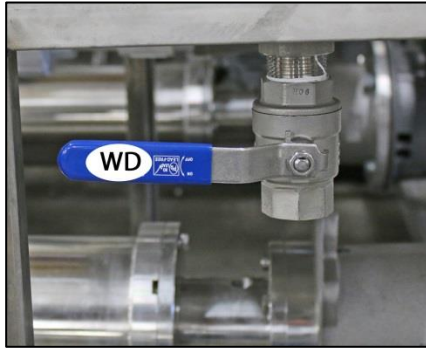

WD – Horizontal Left, valve is closed

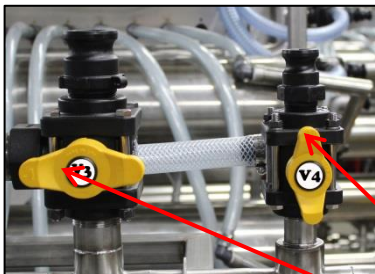

V3 – The flow indicator should be Horizontal Left

V4 – The flow indicator should be Vertical Up



V18 – Horizontal Forward

V19 - With V3 and V4 in the concentrate setting V19 should have no flow. Direct V19 to the wash tank as a precaution. Horizontal Forward

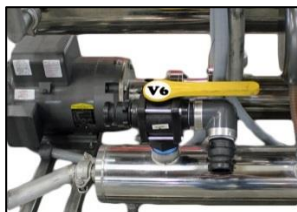

V6 – The flow indicator should be toward the pipe incoming from the liquid source selector. Input from source selector should be from the permeate.



- V41 – Horizontal Left (Open)
- V42 – Vertical Up (Closed)
- V51 – Vertical Up (Closed)
- V52 – Horizontal Left (Open)

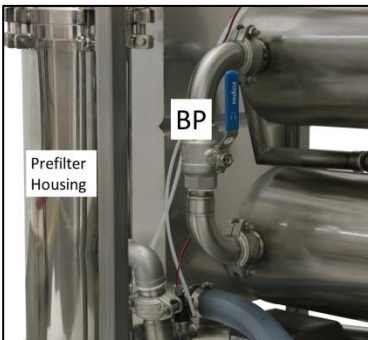

- BP (Membrane Bypass) – Vertical (Open)

1. Press the START button on the control panel. Within 30 seconds all pumps should start.
2. If the system does not continue to run due to a LOW PRESSURE ALARM;
  - a. Light is SOLID - Repeat Step 2 up to 2 additional times. The STOP ALARM RESET button will need to be pressed after each time.
  - b. Light is BLINKING – Press the STOP button to reset the alarm. Check the prefilters, changing as necessary. Repeat Step 2.
3. If the system does not start on the third try, bleed the system. To bleed the system, open the valve on the top of the strainer (installed before valve V6) until all the air is released from the system. Close the bleed valve.
4. Check the concentrate sugar % level approximately every 5 minutes. The Desugar cycle should be run until the concentrate sugar is 1% to 2%.
5. Run a rinse cycle (see page 36).



## Rinse Cycle

In this cycle permeate is run through the system at high volume and low pressure to rinse sugar, minerals and bacteria from the R/O. A rinse cycle is required before and after every wash cycle. At least 1200 US gallons of permeate is required in a rinse following a chemical wash. Desugar and rinsing the system every 4 to 6 hours can help to maintain higher performance rates.

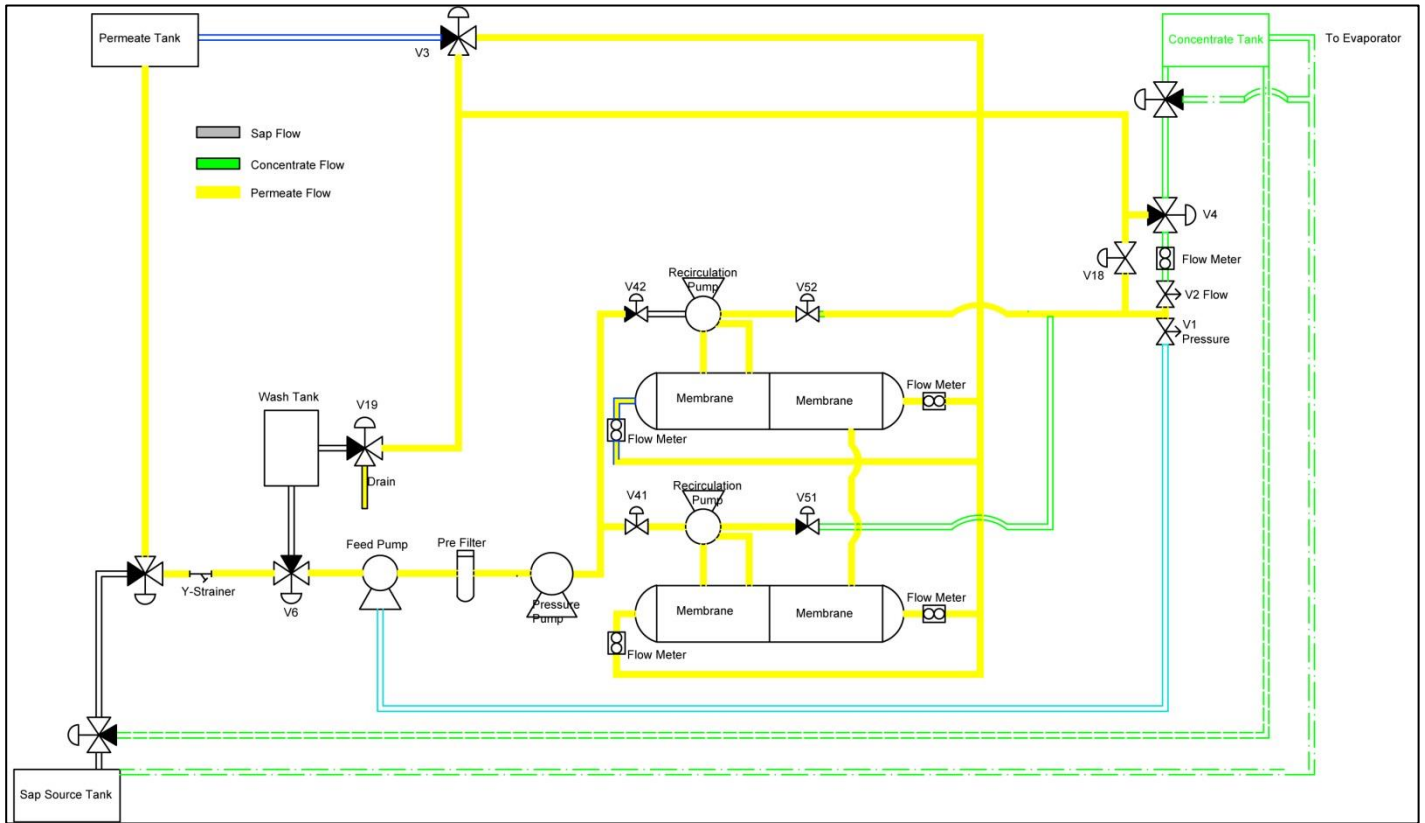

Rinse Cycle Valve Settings – also available on the Quick Start Guide

1. Position the valves as follows:

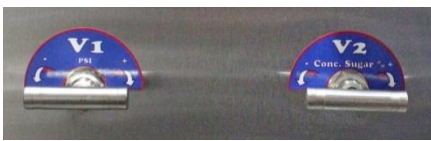

V1 – Fully Open

V2 – Fully Open



WD – Horizontal Left, valve is closed



V3 – The flow indicator should be Vertical Down

V4 – The flow indicator should be Vertical Down



V18 – Horizontal Right



V19 – Vertical Down (to drain)



V6 – The flow indicator should be toward the pipe incoming from the liquid source selector. Input from source selector should be from the permeate.



V41 – Horizontal Left (Open)

V42 – Vertical Up (Closed)

V51 – Vertical Up (Closed)

V52 – Horizontal Left (Open)

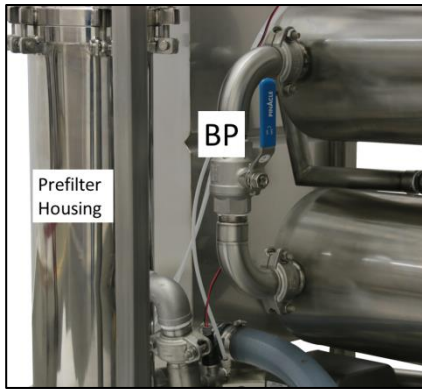

BP (Membrane Bypass) – Vertical (Open)

1. Press the START button on the control panel. Within 30 seconds all pumps should start – some air purge may be required.
2. If the system does not continue to run due to a LOW PRESSURE ALARM;
  - a. Light is SOLID - Repeat Step 2 up to 2 additional times. The STOP ALARM RESET button will need to be pressed after each time.
  - b. Light is BLINKING – Press the STOP button to reset the alarm. Check the prefilters, changing as necessary. Repeat Step 2.
3. If the system does not start on the third try, bleed the system. To bleed the system, open the valve on the top of the strainer (installed before valve V6) until all the air is released from the system. Close the bleed valve.
4. If the system does not start due to a LOW PRESSURE ALARM partially close valve V18 until an operating pressure of 50 – 80psi is reached and run the remainder of the cycle.
5. Run the Rinse cycle until a minimum of 1200 US gallons of stored permeate has been used. If the rinse is to be followed by a wash cycle, fill the wash tank approximately 2/3 full by turning the V19 valve Vertical.

## Wash Cycle

There are three different wash cycles. A hot water wash which can be run when good clear sap was processed and the flows are still good. An alkaline soap wash is done to remove bacteria from the system. An acid soak and wash is done to remove mineral deposits from the system. Generally the acid soak is used where the system does not recover flow rates after the alkaline soap wash.

### Hot Water Wash

1. Perform a rinse cycle (see page 36) using a minimum of 1200 US gallons of permeate stored for system rinsing.
2. Toward the end of the rinse cycle, turn valve V19 toward the wash tank feed position. This will direct the flow of permeate to the wash tank. When the wash tank is  $\frac{2}{3}$  full, return V19 to the drain position.
3. Set the valves as listed below.
4. Start and run the system until it shuts down automatically. The system will shut down when the temperature reaches 118°F.

NOTE: If the machine shuts down due to low pressure, check the prefilters. If the prefilters are dirty, replace and retry the wash cycle. If the prefilters appear clean or are new and the problem continues, partially close valve V18 until an operating pressure of 50 – 80psi is reached and run the remainder of the cycle.

5. Perform a Rinse cycle (see page 36) using a minimum of 1200 US gallons of the stored permeate water.

### Alkaline Soap Wash

1. Perform a rinse cycle (see page 36) using a minimum of 1200 US gallons of permeate stored for system rinsing.
2. Toward the end of the rinse cycle, turn valve V19 toward the wash tank feed position. This will direct the flow of permeate to the wash tank. When the wash tank is  $\frac{2}{3}$  full, return V19 to the drain position.

- At the completion of the rinse cycle, add R/O soap (LEADER Order # 69992) to the wash tank and mix. Add R/O soap until a pH of 11 is reached. NOTE: This applies to FILMTEC E8 membranes. For other membranes consult with a LEADER sales person or a local distributor / dealer.
- Set the valves as listed below.
- Start and run the system. Check the pH of the wash tank solution every 15 minutes. Add soap, if necessary, to maintain the pH. The system will shut down automatically when the temperature reaches 118°F.  
NOTE: If the machine shuts down due to low pressure, check the prefilters. If the prefilters are dirty, replace and retry the wash cycle. If the prefilters appear clean or are new and the problem continues, partially close valve V18 until an operating pressure of 50 – 80psi is reached and run the remainder of the cycle.
- Perform a Rinse cycle (see page 36) using a minimum of 1200 US gallons of the stored permeate water.
- Drain the wash tank. The drain valve is located under the wash tank. Turn the flow indicator to the left.

### Acid Soak

- Perform an alkaline Soap wash as listed above.
- At the end of the rinse cycle (following the wash) turn valve V19 toward the wash tank feed position. Run until the wash tank is approximately  $\frac{2}{3}$  full, return V19 to the drain position.
- Add 2 -  $\frac{2}{3}$  cups of citric acid to the wash tank and mix.
- Run a wash cycle. The system will shut down when the temperature reaches 118°F.
- Shut off the system and allow the acid solution to soak for 8 to 24 hours.
- Drain the wash tank.
- Perform a rinse cycle (see page 36) using a minimum of 1200 US gallons of stored permeate water.
- Perform an alkaline soap wash as detailed above.
- Drain the wash tank.
- Perform a rinse cycle (see page 36) using a minimum of 1200 US gallons of stored permeate water.

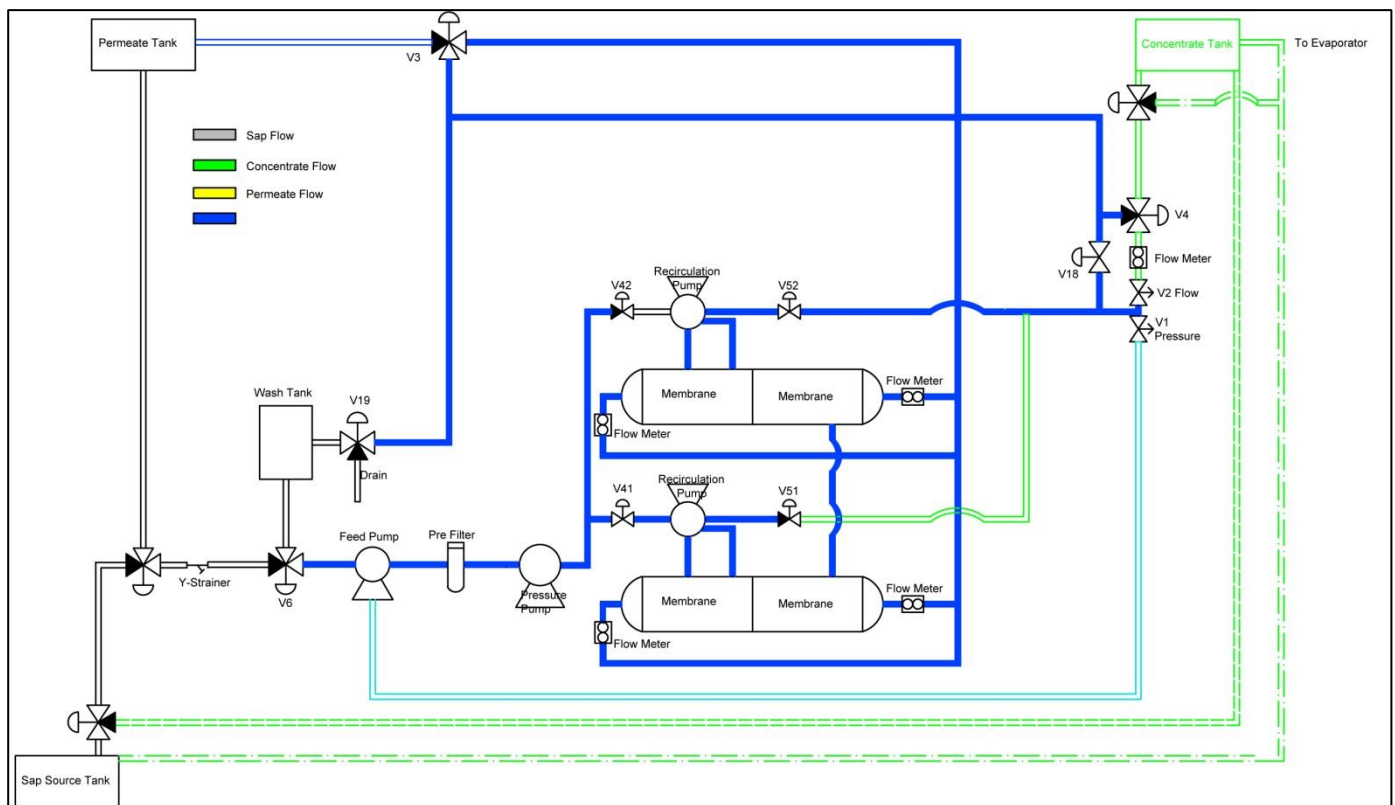

Wash Cycle Valve Settings – also available on the Quick Start Guide

- Position the valves as follows:

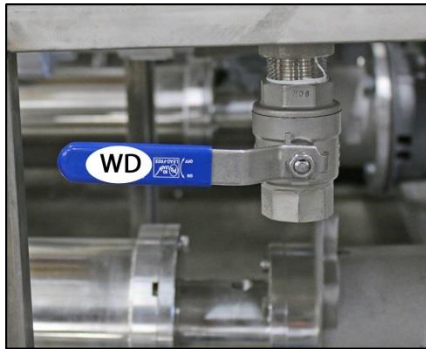

WD – Horizontal Left, valve is closed



V3 – The flow indicator should be Vertical Down

V4 – The flow indicator should be Vertical Down



V18 – Horizontal Right



V19 – Horizontal Forward

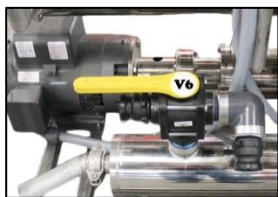

V6 – The flow indicator should be toward the wash tank





- V41 – Horizontal Left (Open)
- V42 – Vertical Up (Closed)
- V51 – Vertical Up (Closed)
- V52 – Horizontal Left (Open)

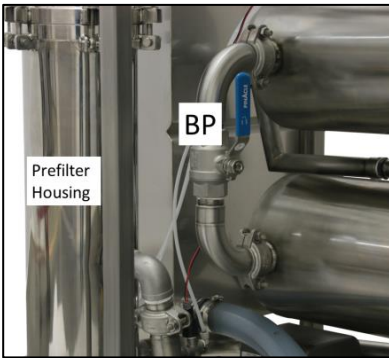

- BP (Membrane Bypass) – Vertical (Open)

2. Add the chemical required for the type of wash to be performed. NOTE: Ensure the wash tank is filled first.
3. Press the START button on the control panel. Within 30 seconds all pumps should start.
4. If the system does not continue to run due to a LOW PRESSURE ALARM;
  - a. Light is SOLID - Repeat Step 2 up to 2 additional times. The STOP ALARM RESET button will need to be pressed after each time.
  - b. Light is BLINKING – Press the STOP button to reset the alarm. Check the prefilters, changing as necessary. Repeat Step 2.
5. If the system does not start on the third try, bleed the system. To bleed the system, open the valve on the top of the strainer (installed before valve V6) until all the air is released from the system. Close the bleed valve.
6. If the system does not start due to a LOW PRESSURE ALARM partially close valve V18 until an operating pressure of 50 – 80psi is reached and run the remainder of the cycle.
7. Press the STOP ALARM RESET button to reset the alarm.
8. For an alkaline soap wash - run the Wash cycle until the system shuts down automatically. The system shutdown is based on the temperature of the liquid. When the liquid reaches 118°F the system will shut down.
9. Open valve WD to drain the wash tank. When the wash tank has drained, return valve WD to the recirculation position.
10. Run a rinse cycle (see page 36) using a minimum of 1200 US gallons of permeate in the permeate storage tank.
11. Do a permeability test (see page 21). If the test is good, continue the rinse cycle with any additional permeate.

## MAINTENANCE

### Prefilters

When the feed pump pressure drops 20 psi or more, the prefilters may need to be changed. The system has two prefilter canisters. Each canister contains five 20" prefilters (LEADER Order #: 70012). The procedure to change the prefilters is as follows:



1. Open the lower drain of the filter housing and allow the liquid to drain from the housing. The draining process can be hastened by opening the upper drain also.



2. Loosen the eye nuts and rotate the bolts off the top of the housing cover.



3. Remove the cover from the housing to expose the compression plate which is held in place by a washer and wing nut.

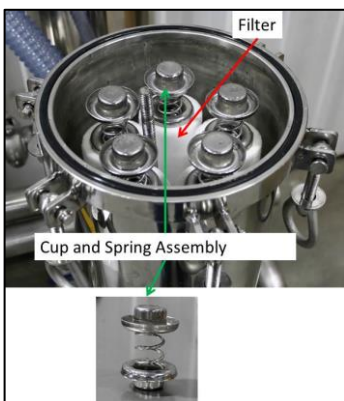

4. Remove the wing nut, washer and compression plate from the top of the filters in the housing. Five filters and associated cup and spring assemblies will be exposed.



5. Remove the cup and spring assemblies from the tops of the filters then remove the filters by pulling straight up so they slide over the guides.



6. Slide the new filters over the guides in the housing.



7. Place one cup and spring assembly into the top of each filter. The projection on the bottom of the cup should fit into the hole in the filter.



8. Place the compression plate over the threaded rod and lower onto the cup and spring assemblies, lining one assembly up in each hole.



9. Secure the compression plate in place by placing the washer over then threading the wing nut onto the threaded rod. Tighten the wing nut.

10. Inspect the O-ring in the housing and replace if necessary. It may also need to be lubricated with food grade grease.



11. Replace the cover, aligning the guides for the eye nuts and secure the eye nuts.



## Membrane Removal and Installation

NOTE: Membrane surfaces could produce splinters during handling. It is recommended clean leather gloves be worn when handling membranes.

### Removal

#### **→Common Steps for Removal of Locking and Non Locking Style E8 Membranes**

NOTE: Each vessel contains two membranes.

1. Stop the system by pressing the STOP button.
2. Position valve V6 to the wash position.
3. Set valves V3 and V4 in a rinse cycle position.
4. Open the drain of the membrane housing to be changed. Allow the membrane to drain until empty.
5. Disconnect the permeate line(s) quick coupler(s) from the ends of the membrane housing. Quick couplers are located on both ends of the membrane housing.

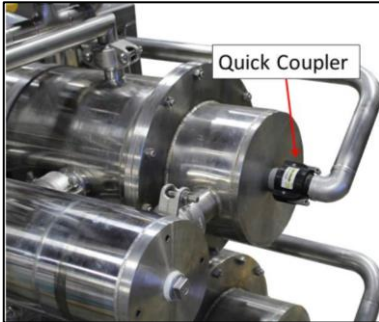

6. Carefully move the permeate pipes to the side.

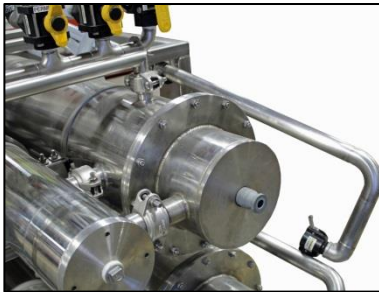

7. Remove the bolts from the metal clamp between the top (right side) of the membrane housing and the recirculation pump.

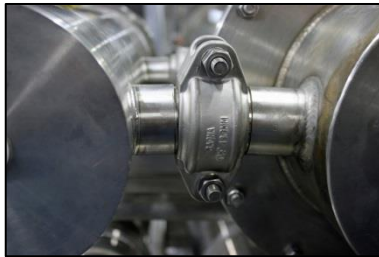

8. Slide the gasket rubber to the pipe on the pump side of the connection.

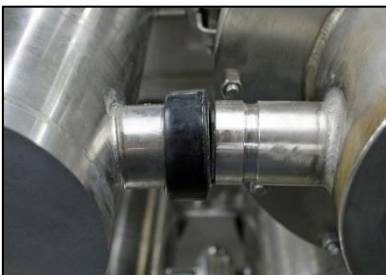

9. Using (2) - 9/16" wrenches remove the bolts fastening the end of the membrane housing to the body of the membrane housing.







10. Remove membrane housing cap from the membrane.

11. Determine the style of E8 membrane installed in the system. Visually check the end of the membrane to determine the style.

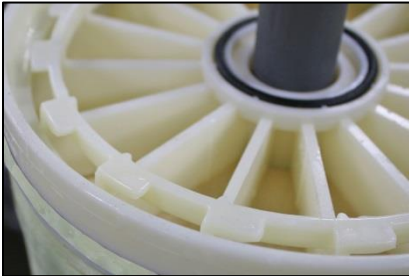

Locking Style E8 Membrane – continue with the section “Removal Of Locking Style E8 Membranes”



Non Locking Style E8 Membrane – continue with the section “Removal Of Non Locking Style E8 Membranes”. There are two styles of Non-Locking Membranes; threaded rod and clamp ring.

### **→Steps for Removal Of Locking Style E8 Membrane**

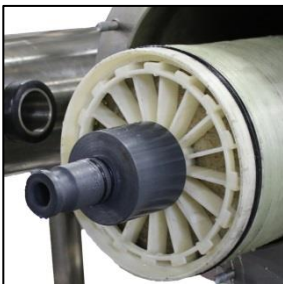

1. Remove the alignment coupling from the end of the membrane(s).

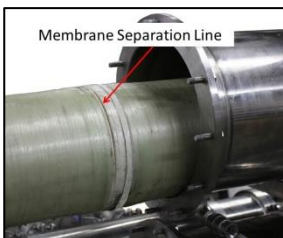

2. Slide the paired membranes out of the vessel until the second membrane can be seen. Twist the outer membrane counter clockwise until the joint between the membranes is unlocked – approximately 1”.

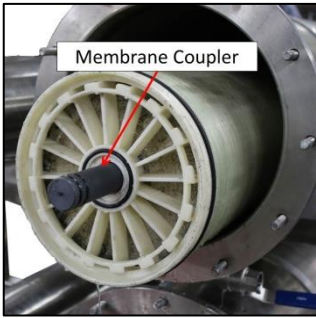

3. Remove the outer membrane then the membrane coupler.
4. Remove the remaining membrane. If the second alignment coupling is still attached to the end of the membrane, remove it.
5. For reinstallation of the membranes, refer to the section "Installation of Hooked Style E8 Membranes"

**→Removal of Non Locking Threaded Rod Style E8 Membranes**



1. Stand the membrane assembly on a clean surface with the threaded rods of the connectors facing up.

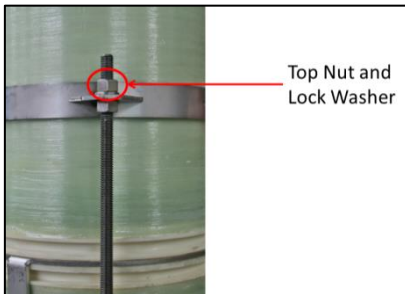

2. Remove the top nuts and washers. There are three sets – one set on each threaded rod. Save the washers and nuts for later use in assembling the membranes.



3. Remove the upper membrane, sliding the clamp over the threaded rods. Turn the remaining nuts until they are approximately  $\frac{1}{2}$ " to  $\frac{3}{4}$ " lower than their original position.



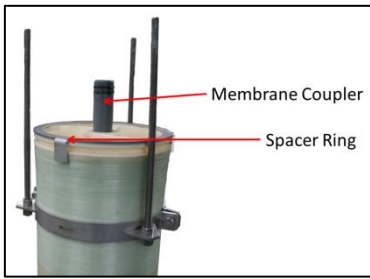

4. Remove the spacer ring from the top of the bottom membrane then remove the membrane coupler.

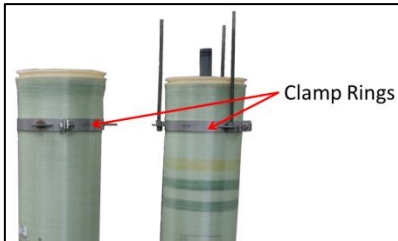

5. Remove the clamp rings from both membranes by removing the bolts securing the two halves of the rings.

**→Steps for Removal Of Non Locking Clamp Ring Style E8 Membranes**

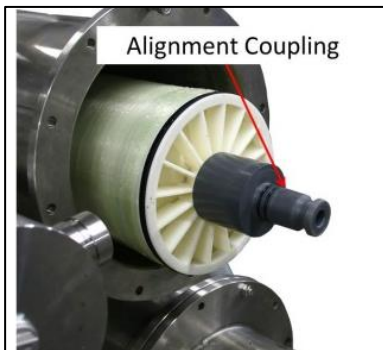

1. Remove the alignment coupling from the end of the membrane.



2. Slide the mated membranes out of the pressure vessel.

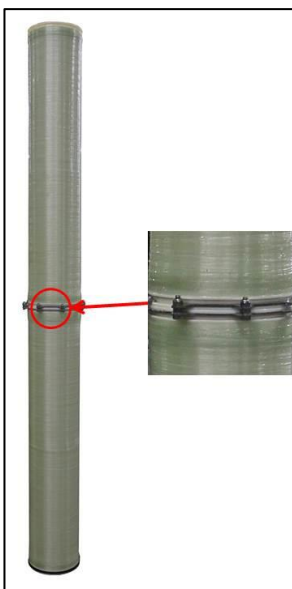

3. Place the membrane assembly on a clean solid surface upright with the nuts of the clamp facing upward.

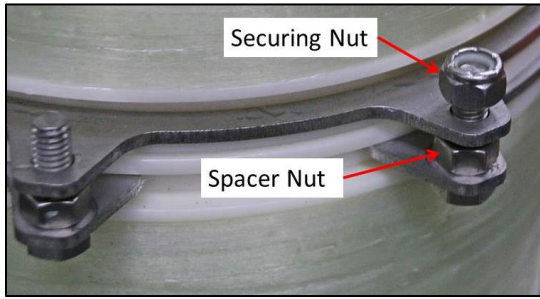

4. Remove all the securing nuts holding the clamp assembly together. Leave the spacer nuts in place.



5. Separate the two membranes by raising the upper membrane to clear the clamp bolts and the connector. Place the membrane on a solid clean surface.

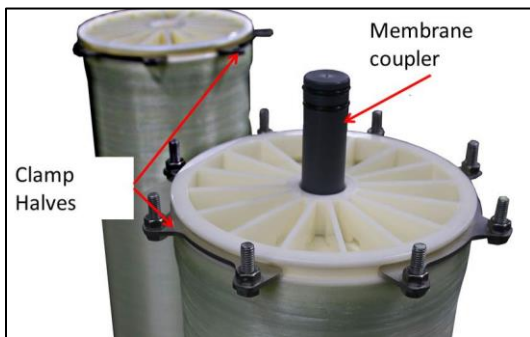

6. Remove the membrane coupler and the clamp halves from each of the membranes.

## Installation

### ***Installation of Membranes – Locking and Non Locking Style E8 Membranes***

#### ***→Steps for Installation of Locking Style E8 Membrane***

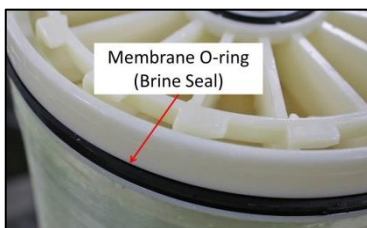

1. Lubricate the membrane O-ring (brine seal) of each membrane with permeate or non-chlorinated well or spring water.



Note: If the brine seal is to be changed or reinstalled into the membrane- when installing the brine seal it is important to insert the brine seal in the correct orientation. The brine seal is shaped like a “U”. The “U” must face toward the vessel cap.

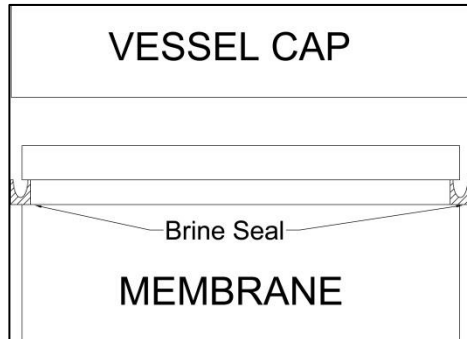

2. Place one membrane on a solid surface such as a clean floor with the O-ring seal on the upper end. Check the O-rings on the membrane connector then lubricate with permeate or non-chlorinated well or spring water. Place the connector into the top of the membrane.

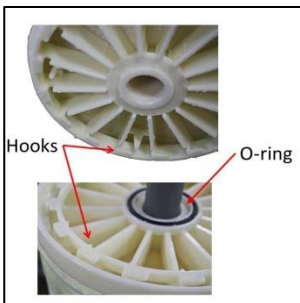

3. Lightly lubricate the membrane O-ring with permeate or non-chlorinated well or spring water then place the second membrane over the connector and aligned so the hooks of the bottom membrane and the hooks of the top membrane will not interfere with the membranes coming together.

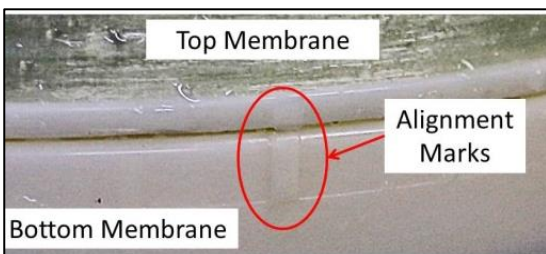

4. Slide the two membranes together until they meet. Turn the top membrane clockwise until the two membranes are locked together. There are indicators on the membranes to confirm the correct positioning.

5. Proceed to the section of Common Steps for Installation.

**→Installation of Non Locking Threaded Rod Style E8 Membranes**



1. Set the membranes to be installed on a stable surface, oriented as shown. Note the position of the brine seal.



Note: If the brine seal is removed and reinstalled -when installing the brine seal it is important to insert the brine seal in the correct orientation. The brine seal is shaped like a “U”. The “U” must face toward the vessel cap.

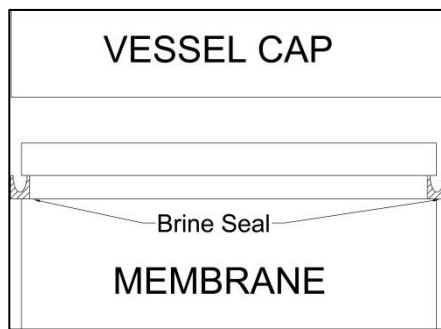

2. Install the clamp ring with the threaded rods onto the membrane without the brine seal. Note the top of the clamp ring is approximately 4” down from the top of the membrane.



3. Install the second clamp ring (without the threaded rods) onto the membrane with the brine seal. The top of the clamp ring is approximately 4” down from the top of the membrane.

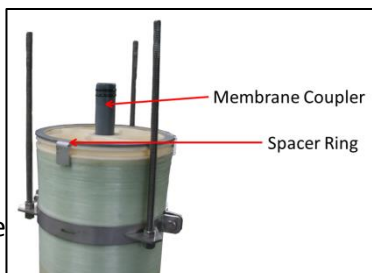

4. Install the spacer ring to the top of the membrane with the rod assembly. Inspect the O-rings on the membrane coupler and replace if necessary.

Lubricate the O-rings of the coupler with permeate or non-chlorinated well or spring water then insert the coupler into the top of the membrane.



5. Turn the membrane with brine seal over and slide it onto the membrane with the rods. Line up the rods with the holes in the clamp of the membrane then slide it down over the rods and the membrane coupler until it rests on the spacer ring.

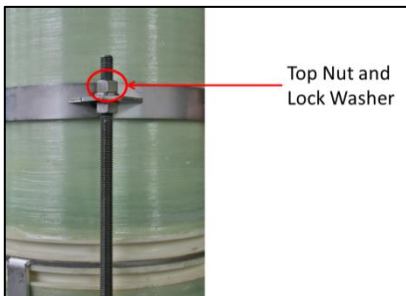

6. Place a lock washer onto each of the three threaded rods. Thread a nut down each of the three threaded rods until it is resting on the lock washer. The lock washers and nuts to be used were those from the disassembly of the membranes.



7. Thread the bottom nut of each of the three threaded rods up until it touches the bottom of the clamp ring of the top membrane. Using 9/16" wrenches, hold the nut under the top membrane clamp and tighten the top nut.

### →Installation of Clamp Ring Style Non-Locking E8 Membranes



1. Place a membrane on a clean solid surface with the brine seal on the top end. Remove the brine seal.





2. Insert the clamp assembly half without the bolts into the brine seal groove.

3. Place a second membrane on a clean sold surface with the brine seal down.



4. Insert the membrane coupler into the end of the membrane.



5. Insert the clamp assembly half into the groove at the top portion of the membrane with the bolts pointed up.

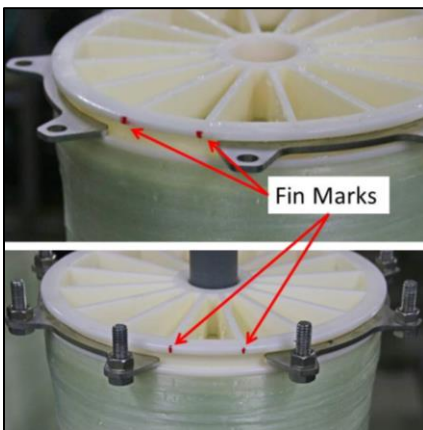

6. Using a marker, mark the outside edge of the clamp end of each membrane where two adjoining support fins meet the outer rim.

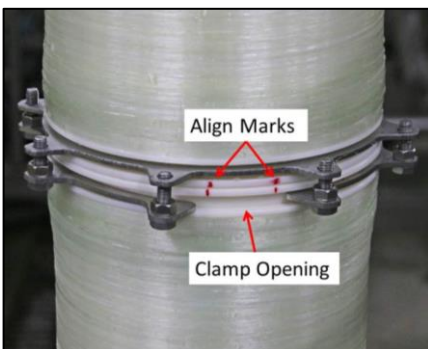

7. Place the membrane with the clamp assembly half with no bolts onto the other membrane aligning as follows;

- a. Center over the connector
- b. Clamp openings to be on opposite sides of the assembly
- c. Find marks to be aligned



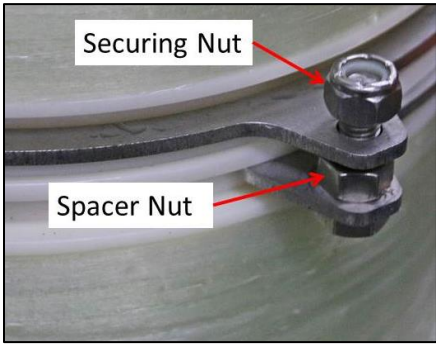

8. Secure the two clamp assembly halves together by tightening a nut with insert onto each bolt.

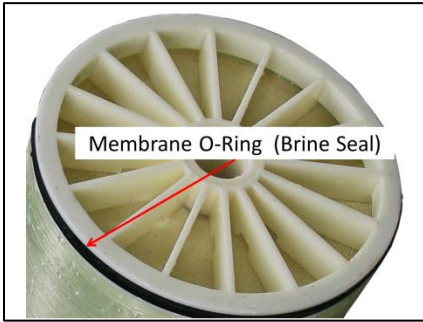

9. Lubricate the membrane O-ring (brine seal) of the bottom membrane with permeate or non-chlorinated well or spring water.



Note: When installing the brine seal it is important to insert the brine seal in the correct orientation. The brine seal is shaped like a “U”. The “U” must face toward the vessel cap.

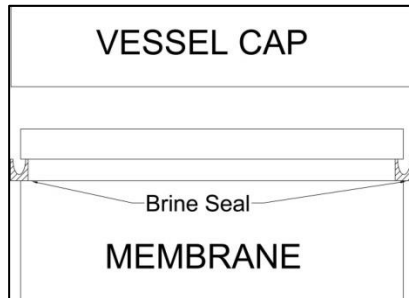

10. Proceed to the Common Steps for Installation section.

→Common Steps for Installation of Membranes



1. Inspect and replace if necessary the four (4) O-rings on the alignment couplings used on both ends of the membranes. Lubricate the O-rings with permeate or non-chlorinated well or spring water.
2. Slide the assembled membranes into the membrane housing. Ensure the membrane goes all the way into the housing with the membrane coupling at the left end of the housing seated into the membrane and the coupling is in the hole at the end of the housing.

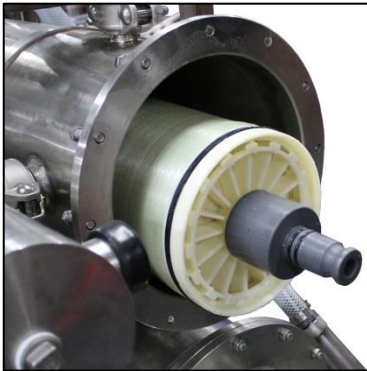

3. Insert the membrane coupling into the end of the membrane.

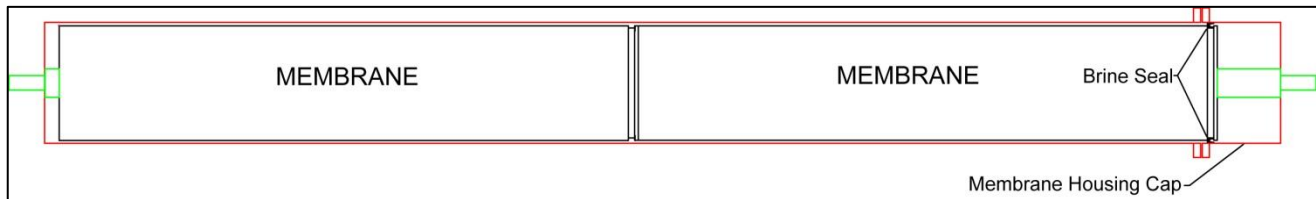

4. Inspect the O-rings on the membrane housing cap, replace if damaged. Lubricate the O-rings with permeate or non-chlorinated well or spring water, if necessary. Install the membrane housing end cap aligning the pump connection on the cap with the recirculation pump pipe.

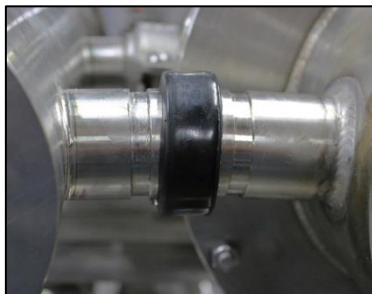

5. Reinstall and loosely tighten the bolts and nuts around the housing cap.
6. Slide the clamp rubber coupler over the membrane housing pipe so that it rests between the grooves.

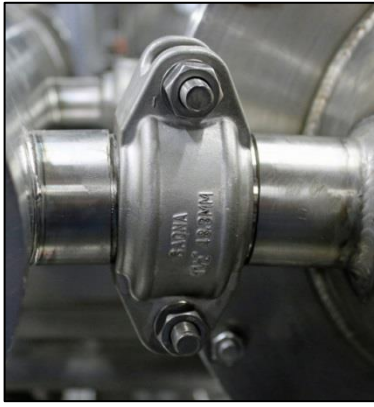

7. Place the two clamp halves over the rubber seal and aligning the pieces with the grooves in the connector pipes. Place the bolts in the clamp and tighten. Check to ensure the clamp is properly seated and tightened by ensuring the two halves fit tightly together.



8. Securely tighten the nuts and bolts of the membrane housing cap. It is recommended the bolts be tightened in a crisscross pattern.



9. Reconnect the permeate lines at each end of the membrane housing using the quick couplers.

10. Follow the instructions for the Beginning of Season Startup (see page 58).

## Daily

Each day, it is recommended the following be done:

1. Remove, clean and reinstall the strainer in the Y-strainer.
2. Sample the permeate from each permeate sample port.
  - a. Purge the permeate sample lines by running the system and drawing a volume of permeate from each port approximately equal to a test cup.
  - b. Draw a sample for testing. Test the permeate sugar level using either a refractometer or a hydrometer.
  - c. If the results indicate there is any sugar present there is a possible problem with the membrane O-rings, connector or alignment couplings. Check the troubleshooting chart.
3. Check all hoses, piping, fittings and connections for leaks. Repair as necessary.
4. Run a cycle of Desugar (see page 32) – Alkaline Soap Wash (see page 38)
5. Do a Permeability test (see page 21)
6. Inspect and clean storage tanks
  - a. Permeate
  - b. Concentrate
  - c. Sap

## Periodic

1. When the feed pump pressure drops 20 psi or more, the prefilters need to be inspected and if necessary, changed (see page 42).
2. Pump motors will need to be lubricated. The following table describes the lubrication requirements. NOTE: The output of the grease gun will need to be measured prior to lubricating the bearings in order to ensure the proper amount of lubrication is used.
  - d. All bearings require EXXON POLYREX EM lubricant.

**NOTE: Lubricate the bearings ONLY at the interval specified. Over lubrication will cause the bearings to fail.**

MOTOR FUNCTION	HP	Bearing Location	Lubrication Interval (hrs)	Lubrication Amount (ounces)		Bearing Location	Lubrication Interval (hrs)	Lubrication Amount (ounces)
Feed Pump	7.5	Pump end	3600	6.1		Non Pump End	3600	3.9
Pressure Pump	10	Pump end	3600	8.4		Non Pump End	3600	5
Recirculation Pump	3	Pump end	5500	5.0		Non Pump End	5500	3.9

## End of Season Shutdown and Storage

If permeate is not available to perform the rinse and wash cycles stated in the following procedure, obtain the necessary volume of water using non chlorinated well or spring water.

The following flow chart outlines the steps to follow for the first steps in preparing the system for shutdown. Note the text version follows in Steps 1 – 4.

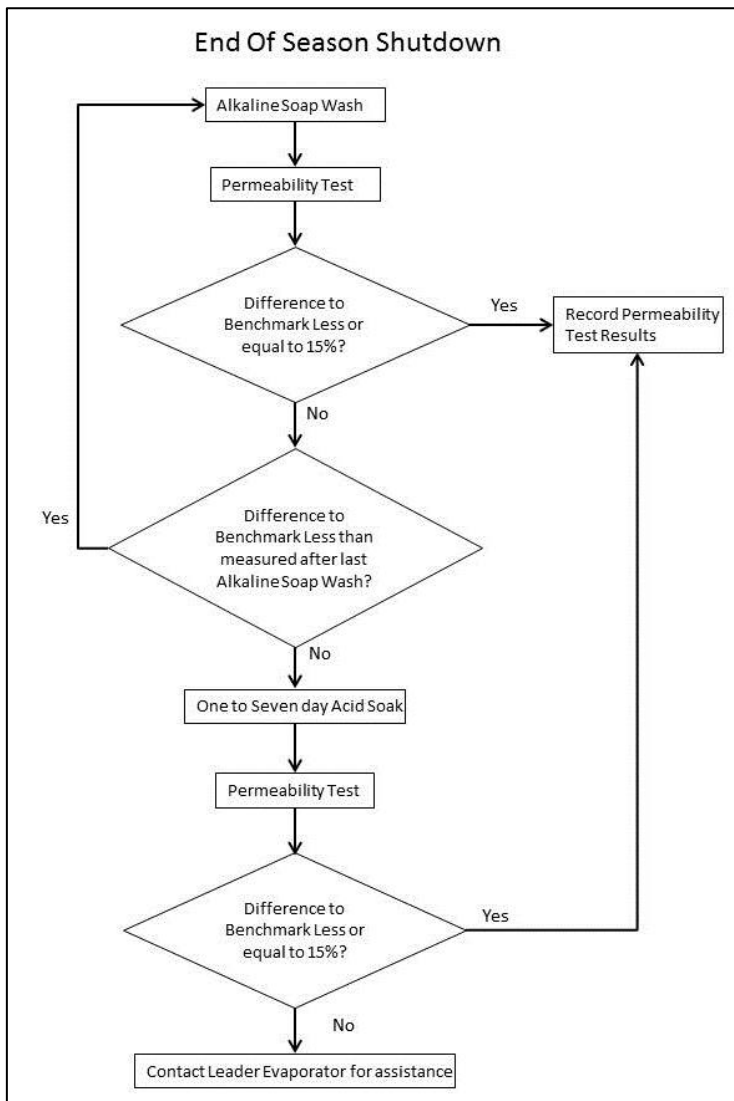

1. Do an alkaline soap wash (see page 38).
2. Run a permeability test. Compare the results to the benchmark used at the beginning of the season.
  - a. If the results show a difference of greater than 15% and the difference in the percentage is less than the previous alkaline soap wash cycle, repeat the alkaline soap wash cycle.
  - b. If the results show a difference greater than 15% and there was no improvement as compared to the previous alkaline soap wash cycle continue to the next step – Acid Soak Cycle.
  - c. If the difference is 15% of less, continue with Step 4.
3. Do an acid soak cycle (see page 39) allow the machine to soak for 1 to 7 days starting the system on the first day and allowing it to run to the auto shutdown temperature of 118°F. Run the system to temperature the same way on the last day of the cycle. Run a permeability test (see page 21).
4. If the difference in results is 15% or less – record the permeability test results. If the results are greater than 15%, contact Leader Evaporator for assistance.
5. Drain the wash tank (valve WD) then close the drain.
6. In the wash tank mix:
  - a. 18 US gallons of permeate
  - b. 2 US gallons of glycol
  - c. 4 teaspoons of membrane preservative

7. Set the system valves for a wash cycle (see page 38) and run the system for 15 minutes. Drain the wash tank.
8. Empty then reinstall the prefilter housings.
9. Drain the pumps and close the drains for storage.
10. Maintain a temperature of 40°F to 50°F in the area where the system is stored. Do not allow the system to freeze.
11. Drain and clean all storage tanks. Cover them in order to keep dirt and pests out. NOTE: If permeate is not available for cleaning, use non-chlorinated well or spring water.

## Beginning of Season Startup

As permeate will not be available to perform the rinse and wash cycles stated in the following procedure, obtain the necessary volume of water using non chlorinated well or spring water.

1. Connect the reverse osmosis system to the concentrate, permeate and feed lines.
2. Replace prefilters (see page 42).
3. Open the control box by turning the latches on the right side of the panel then opening the door carefully to the left.
4. Turn off the pressure and recirculation pump breakers:



BREAKER ID	CIRCUIT	START POSITION
CB1	Feed Pump	ON
CB2	Pressure Pump	OFF
CB3	Recirculation Pump	OFF
CB4	Recirculation Pump	OFF

5. Close the control box cover and turn the latches to fasten.
6. Ensure your source valves (water or permeate) are open to feed the system.
7. Position the valves for the rinse cycle (see page 36).
8. Press the START button to start the feed pump.
9. Run the feed pump until most of the bubbles are gone from the flow meters located on the front of the system. This will take 3 to 4 minutes. Not all the bubbles can be removed.
10. Press the STOP button to stop the feed pump.
11. Check all fittings, hoses, connections and parts of the system for leaks. Repair as necessary.
12. Open the control box by turning the latches on the right side of the panel then opening the door carefully to the left.
13. Position breakers CB1, CB2, CB3 and CB4 to the ON position.
14. Close the control box cover and turn the latches to fasten.



15. Run a rinse cycle (see page 36) until a minimum of 1200 US gallons of water have been processed. Near the end of the rinse cycle turn valve V19 down and fill the wash tank 2/3 full. Return valve V19 to its original position.
16. Run a hot water wash cycle (see page 38).
17. Repeat the rinse cycle (see page 36) again filling the wash tank as specified then add R/O soap (LEADER Order # 69992) to the wash tank and mix. Add R/O soap until a pH of 11 is reached.
18. Run an alkaline wash cycle (see page 38).
19. Perform a rinse cycle (see page 36) using a minimum of 1200 US gallons of water.
20. Perform a permeability test (see page 21).
  - a. Compare the results to the results of the test when the system completed preparations for the previous seasons shutdown. If the results are not acceptable contact LEADER EVAPORATOR or your local Distributor / Dealer for assistance.
12. Record the results, if acceptable, and use these results as the reference for test for the season.

## TROUBLESHOOTING CHART

The following conditions may occur during operations.

CONDITION	CAUSE	ACTION
Feed pump does not start when START button is pressed	No power	Verify power is "ON" at the source.
Feed pump starts but system does not continue running – Low Pressure Alarm	Low Pressure	Inspect incoming plumbing for leaks
		Check and clean Y-strainer
		Pre Filters need changing
	No liquid coming from storage	System needs to be bled
	No liquid coming from storage	Check the positions of all valves
Low rate found during permeability test	Suspected bacteria buildup	Rewash system with R/O alkali soap
	Suspected Mineral Buildup	Acid wash system
Sugar in the permeate	Leak at alignment coupling or membrane plug	Replace O-ring or alignment coupling or the membrane connector
	Membrane deterioration	Replace membrane
Temperature Alarm Indicator	Normal operations for wash cycle	Reset alarm by pressing the STOP button
Motor Failure Alarm Indicator	Motor contactor has tripped	Contact LEADER Technical Service

# ATTACHMENT #1 – ELECTRICAL SCHEMATIC – With Pressure Differential Switch

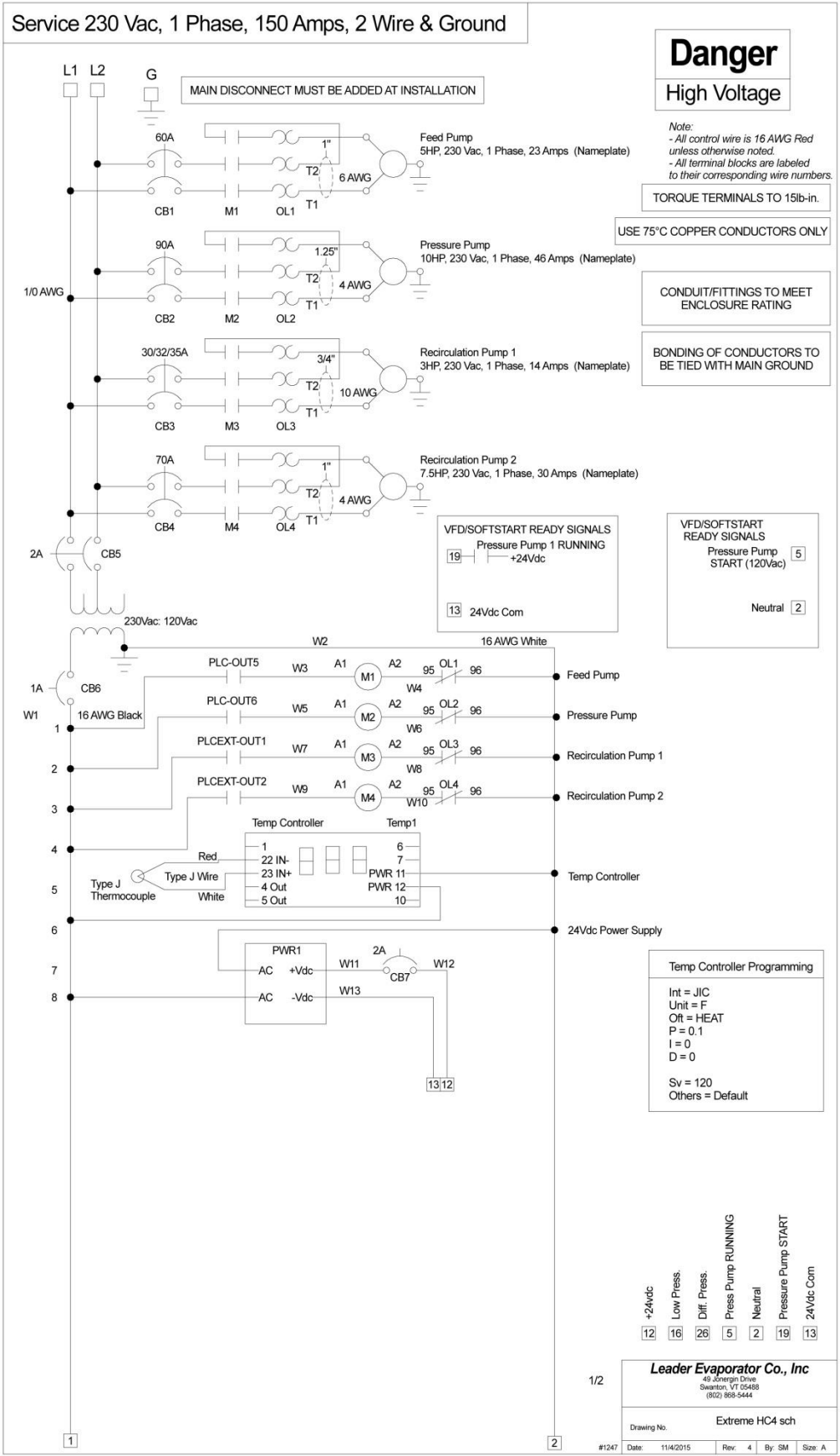

Note:  
 - All control wire is 16 AWG Red unless otherwise noted.  
 - All terminal blocks are labeled to their corresponding wire numbers.

TORQUE TERMINALS TO 15lb-in.

USE 75°C COPPER CONDUCTORS ONLY

CONDUIT/FITTINGS TO MEET ENCLOSURE RATING

BONDING OF CONDUCTORS TO BE TIED WITH MAIN GROUND

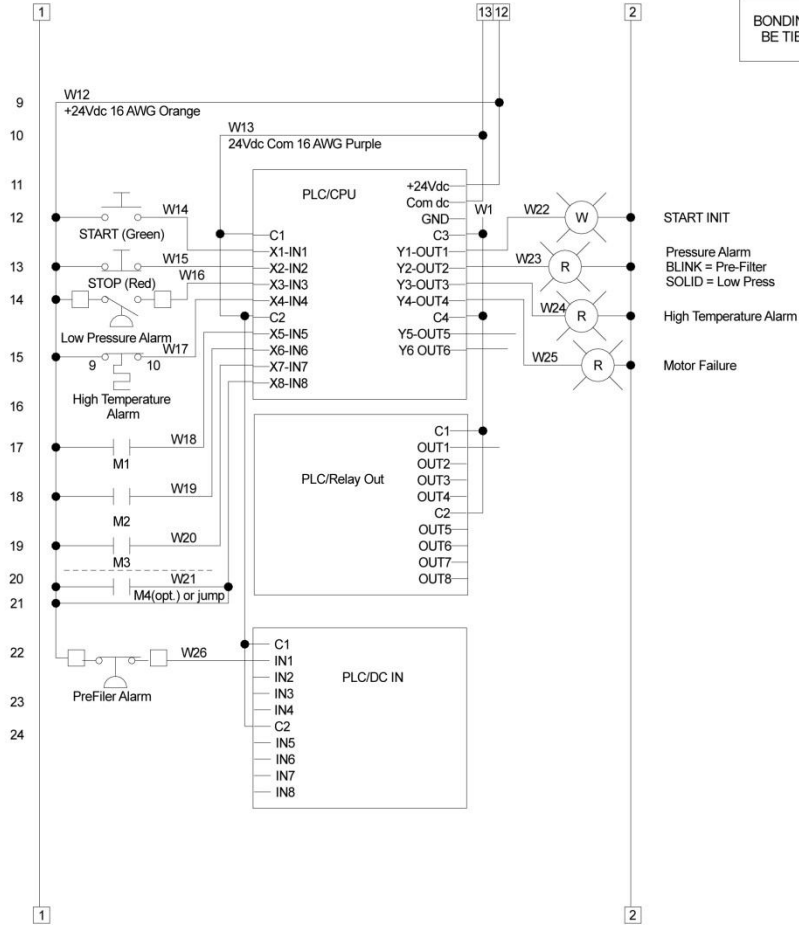

2/2

<b>Leader Evaporator Co., Inc</b>			
49 Jönköping Drive Swanton, VT 05488 (802) 868-5444			
Drawing No. <b>Extreme HC4 sch</b>			
#1247	Date: 11/4/2015	Rev: 4	By: SM Size: A

## ATTACHMENT #2 – OPERATIONS DATA LOGSHEET

Water Removal % = ((permeate 1 flow + permeate 2 flow + permeate 3 flow + permeate 4 flow) / (permeate 1 flow + permeate 2 flow + permeate 3 flow + permeate 4 flow + concentrate flow))\*100

GPH Processed = (permeate 1 flow + permeate 2 flow + permeate 3 flow + permeate 4 flow + concentrate flow)\*60

### SPRINGTECH EXTREME HC-4 OPERATIONS DATA

	DATE								
	ACTIVITY (C or T)								
SUGAR CONCENTRATION	SAP								
	CONCENTRATE								
FLOW (gpm)	PERMEATE 1								
	PERMEATE 2								
	PERMEATE 3								
	PERMEATE 4								
	CONCENTRATE								
	TEMPERATURE								
PRESSURE (psi)	FEED PUMP								
	MEMBRANE								
	WATER REMOVAL %								
	GPH PROCESSED								

	DATE								
	ACTIVITY (C or T)								
SUGAR CONCENTRATION	SAP								
	CONCENTRATE								
FLOW (gpm)	PERMEATE 1								
	PERMEATE 2								
	PERMEATE 3								
	PERMEATE 4								
	CONCENTRATE								
	TEMPERATURE								
PRESSURE (psi)	FEED PUMP								
	MEMBRANE								
	WATER REMOVAL %								
	GPH PROCESSED								







Leader Evaporator Co., Inc.  
49 Jonergin Drive  
Swanton, VT 05488  
Tel: (802) 868-5444  
Fax: (802) 868-5445  
[www.leaderevaporator.com](http://www.leaderevaporator.com)

---

## **Leader Evaporator Manufacturer's Warranty For Springtech Extreme Reverse Osmosis Machines**

Leader Evaporator Co., Inc. warrants our Springtech Extreme line of Reverse Osmosis Machines against any manufacturer defects for a period of two years from the date of purchase. This warranty is at the discretion of the manufacturer, Leader Evaporator Co., Inc., to be replaced or repaired, as necessary. All replaced parts become the manufacturer's property. Leader Evaporator Co., Inc. shall not be held responsible for any damage or injury arising from negligence, abuse, improper handling or installation.