

USER MANUAL

REVERSIBLE CROSS FLOW PAN SET FOR MAX COMBO AND RAISED FLUE PAN



LEADER[™]
WE HELP YOU GET MAPLE DONE

LEADER EVAPORATOR
49 Jonergin Drive
Swanton, VT 05488
(802) 868-5444
LeaderEvaporator.com

TABLE OF CONTENTS

EQUIPMENT DESCRIPTION	3
EQUIPMENT DESCRIPTION LIST:.....	6
OPTIONAL SETUP EQUIPMENT, SPARE PARTS AND OPERATIONAL SUPPLIES.....	8
RECEIVING YOUR-CROSS FLOW PANS:	9
SETTING UP THE PANS:	10
BUTTERFLY VALVE.....	10
CLAMPS WITH TEFLON SEALS	13
SLIP FITTINGS	14
PREPARING THE ARCH.....	14
<i>Raised Flue Pan</i>	14
<i>For Max Combo Pans</i>	15
SETTING THE PANS.....	16
<i>Placing the Flue Pan</i>	16
<i>Max Combo Flue Pan</i>	16
<i>Installation of the Distribution Box and Pipe</i>	17
<i>Placing the Syrup Pans</i>	17
<i>Float Box Installation</i>	18
Regulator Float Box	18
Hot Sap Box.....	19
<i>Installation the Draw Off Valves</i>	19
Pans Sets Width up to and including 30"	19
Pan sets 40" and 48" in Width	20
Pan Sets 5 and 6 Foot.....	22
<i>Installation of the Connecting pipes</i>	23
<i>Installation of the Regulator Floats</i>	24
<i>Completing the Pan Setup</i>	26
FIRST PAN CLEANING:	29
THEORY OF OPERATION	30
FORMING THE GRADIENT	30
<i>Proper Operations To Maintain The Gradient</i>	30
Firing.....	30
Defoamer.....	31
Minimize Reversal Effects.....	31
OPERATING THE EVAPORATOR	32
CHECK THE EVAPORATOR	32
REVERSAL OF SYRUP PANS	32
MAKING SYRUP	35
DAILY SHUTDOWN	37
<i>Wood Fired</i>	37
<i>Oil Or Gas Fired</i>	37
MAINTENANCE	38
DAILY.....	38
PERIODIC.....	38
END OF SEASON.....	40
BEGINNING OF SEASON STARTUP	41
FEEDBACK	41
ATTACHMENT #1: HYDROMETERS	42
HYDROMETER FUNCTION.....	42
USE OF A HYDROMETER.....	42
PREPARING A NEW HYDROMETER FOR USE.....	42
USING THE HYDROMETER	42

EQUIPMENT DESCRIPTION

The Reversible Cross Flow pan set combines the features of the cross flow syrup pan and the Leader Revolution pan sets. The combination offers the user the cross flow pan set with the ease of reversing the flow in the syrup pans without the necessity of changing the positions of the pans.

There are three configurations of the cross flow pans. The configurations are based on the width of the pans. The configurations are;

- Pans up to 30" in width
- Pans 36" to 48" in width
- Pans over 48" in width.

Pans up to 30" in width – have draw off box elbows with threaded ends connecting to stainless steel ball valves

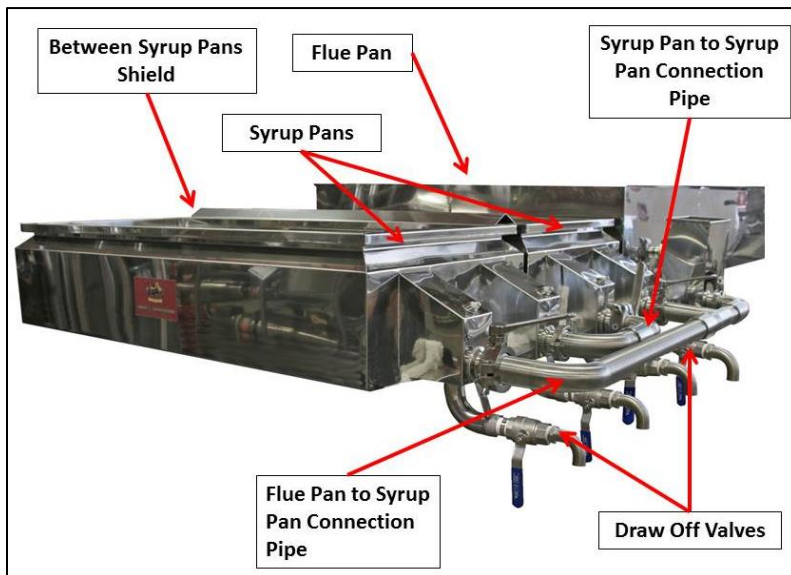

Pans 36" to 48" in width – have draw off box elbows with 1-1/2" flanged ends connecting to adapters and ball valves

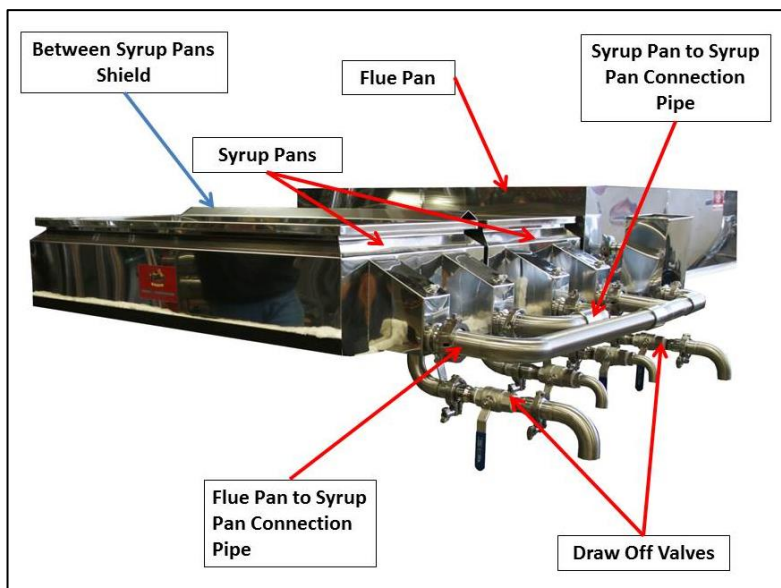

Syrup pans over 48" in width – have draw off box elbows with 2" flanged ends connecting to butterfly valves

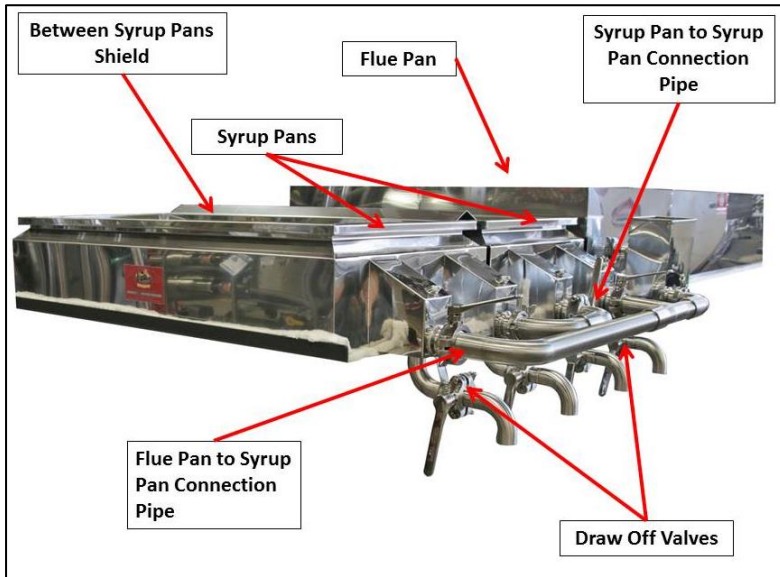

Syrup pans manufactured prior to 2017 may have an open draw off box configuration with each box having a 1" ball valve attached. See the picture below.



Slip Fittings have been added in the flue pan to syrup pan connection pipe to ease the assembly process. The pipe will slide / slip to length to aid in aligning the fittings on the pan and on the pipe section. Additionally, a butterfly valve is supplied in the syrup pan to syrup pan connector pipe. This allows for removal of the front syrup pan without the necessity of draining both syrup pans.

SYRUP PANS

FLUE PAN

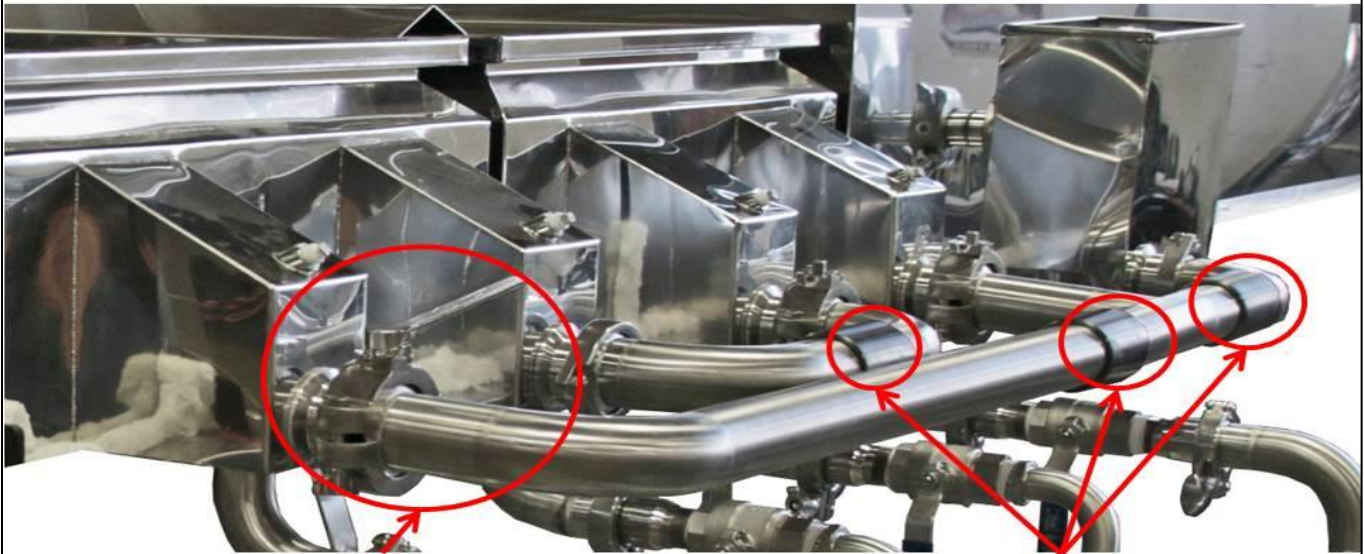

BUTTERFLY VALVE

SLIP FITTINGS

Equipment Description List:

ITEM	LEADER ORDER #	DESCRIPTION / PHOTO	ITEM	LEADER ORDER #	DESCRIPTION / PHOTO
Common Items					
Cross Flow Syrup Pan	As Ordered		Flue Pan	As Ordered	
Regulator Float Box	As Ordered (Left or Right Feed)		Cold Sap Float	59025	
Regulator Packing – Regulator and Z-Arm	59065		Hot Sap Z-Arm	59051	
Hot Sap Regulator Box			Hot Sap Float	59028	
Box Brace			Allen Wrench for Butterfly Valves	60140	
2" Butterfly Valves QTY: 3 for two syrup pans, QTY: 4 for 3 syrup pans	60116		1 -1/2" Butterfly Valve	60115	
2" Heavy Clamp QTY: 4 for 2 syrup pans, QTY: 5 for 3 syrup pans	72246		2" Teflon Seal QTY: 4 for 2 syrup pans, QTY: 5 for 3 syrup pans	65620	
Distributor Pipe			Distribution Box (may be installed on the end of the Distributor Pipe)		
CONNECTION PIPES – will vary with number and size of syrup pans – design is as illustrated			2" Syrup Pan to Syrup Pan Connection Pipe (Qty: 2 if 3 syrup pans)		

ITEM	LEADER ORDER #	DESCRIPTION / PHOTO	ITEM	LEADER ORDER #	DESCRIPTION / PHOTO
Syrup Pan Joint Cover NOTE: If you have a 3 syrup pan set you will receive 2 of this cover			Ceramic Pan Gasket	36" – 65162 72" - 65168	
Flue Brush	60058				

Syrup Pan Draw Off Items



Widths up to and including 30"

1" Stainless Steel Ball Valve QTY: 4	60106		1" Stainless Steel Close Nipple QTY: 4	72111	
1" Stainless Steel Draw Off Elbow QTY: 4	59105				

Widths 36" up to and including 48"

1" Stainless Steel Ball Valve QTY: 4 for 2 syrup pans, QTY: 6 for 3 syrup pans	60106		1" Stainless Steel Draw Off Elbow QTY: 2 for two syrup pans, QTY: 4 for 3 syrup pans	59105	
1 – ½" Stainless Steel Draw Off Elbow QTY: 2 for 2 or 3 syrup pans	59106		1" to 1 – ½" Stainless Steel Adapters NPT to C QTY: 6 for 2 syrup pans, QTY: 8 for 3 syrup pans	610005	
1 – ½" Heavy Clamp QTY: 6 for 2 syrup pans, QTY: 8 for 3 syrup pans	72246		1 – ½" Teflon Seal QTY: 6 for 2 syrup pans, QTY: 8 for 3 syrup pans	65620	

Widths 5' and 6'

2" Butterfly Valves QTY: 4 for two syrup pans, QTY: 6 for 3 syrup pans	60116		2" Stainless Steel Draw Off Elbow QTY: 4 for 2 syrup pans, QTY: 6 for 3 syrup pans	59106	
--	-------	---	--	-------	---

ITEM	LEADER ORDER #	DESCRIPTION / PHOTO	ITEM	LEADER ORDER #	DESCRIPTION / PHOTO
Flue Pan Drain Items					
Raised Flues up to and including 36" in Width					
¾" Stainless Steel Ball Valve	60104		¾" Stainless Steel 8" Nipple	72124	
All Max Flue Pans and Raised Flues over 36" in Width					
1 1/4" Stainless Steel Ball Valve for MAX flue pans or flue pans 40" or wider	60104		1 1/4" Stainless Steel 8" Nipple for MAX flue pans or flue pans 40" or wider	72124	

Optional Setup equipment, Spare Parts and Operational Supplies

ITEM	LEADER ORDER #	DESCRIPTION / PHOTO
Thermometer 3" face, 9" stem (Other sizes and configurations are available)	61025	 Two are recommended – one for each draw-off compartment of the syrup pan
Brush, Inside	60062	
1 ¼" Stainless Steel Close Nipple QTY: 2	72340	
½" Stainless Steel Ball Valve	60100	
Stainless Steel Slip Fitting 2"	72341	
Food Grade Grease	55095	

ITEM	LEADER ORDER #	DESCRIPTION / PHOTO
Rail Gasket	65154 (1/2" X 2" X 25') 65157 (1" X 2" X 25')	
Pan Gasket Holder	Available in 24", 30", 36", 40", 48", 60", 72" widths	
1 ¼" Stainless Steel Tee	72316	
½" Stainless Steel Close Nipple	72101	
O-Ring 226 (for slip fitting)	70179	
Stack Thermometer	61052	 Install at shoulder to eye level in the smoke stack

ITEM	LEADER ORDER #	DESCRIPTION / PHOTO
1 ¼" to ½" Stainless Steel Adapter	72344	
Leader Smart Draw-off Sized from ¾" to 2"		
Green Gloves	63125	
Short Syrup Hydrometer – for use with 59007 Short Test Cup	61040	
Long Syrup Hydrometer – for use with Tall Test Cup	61067	
Pan Cleaner 1 Quarter	63006 Also available in 1 gallon and 5 gallon containers	
Small Skimmer	59004	
Large skimmer	59003	

ITEM	LEADER ORDER #	DESCRIPTION / PHOTO
Firing Gloves	63123	 For wood fired arches
4 oz Defoamer Also available in quarts and gallons	63015	
Short Test Cup 2" Diameter	59007	
Tall Test Cup	59006	
Small Scoop	59002	
Large Scoop	59001	
Grading Set, Temporary	62081	

RECEIVING YOUR-CROSS FLOW PANS:

Upon receipt of your pan set, it is recommended you perform the following tasks:

1. Protect all incoming materials from damage and the environment. If possible place the equipment at the location where it will be setup.
2. Unpack all materials and check what you received against the Equipment Description list provided above.
3. Immediately notify Leader Evaporator or your local dealer if there are questions on the received equipment.

SETTING UP THE PANS:

NOTE: All directions as to arch sides are as if you were facing the front of the arch.

NOTE: The following instructions are for the equipment listed. If instructions for the setup and use of additional equipment are needed please check the Leader Evaporator website, www.leaderevaporator.com, under the Information Resources option.

The instructions in this document describe the setup of a 2 syrup pan set of reversible flow pans. If you are to setup a 3 syrup pan set you will have one more clamp, pan gasket, butterfly valve and syrup pan to syrup pan pipe as in the following illustration:

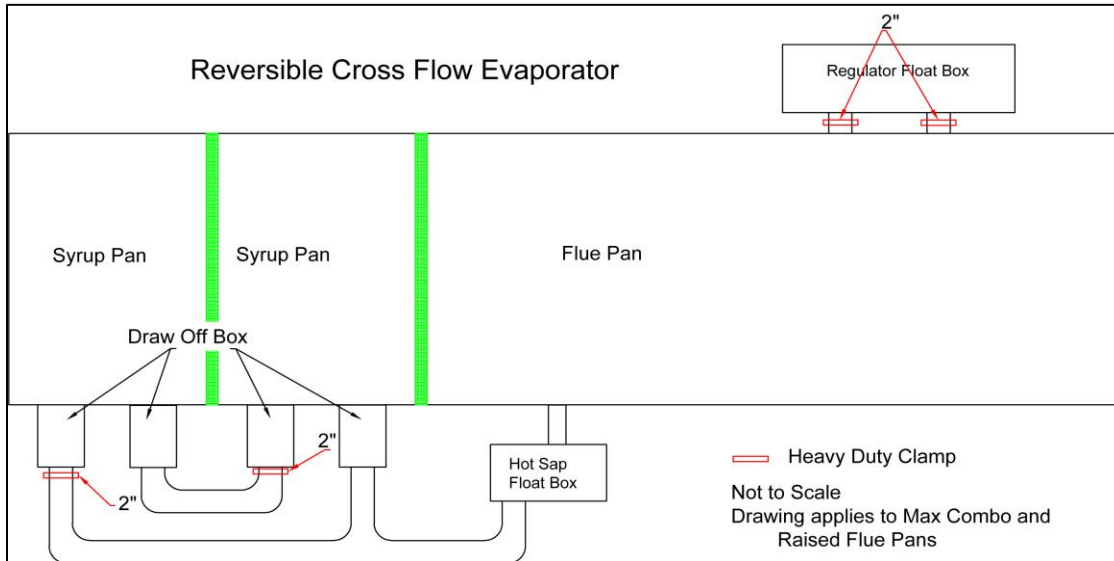

Butterfly Valve

NOTE: Do NOT install or remove this valve without first disassembling. If not fully disassembled, the rubber section cannot be aligned properly and will be damaged.

Butterfly Valve Locations:

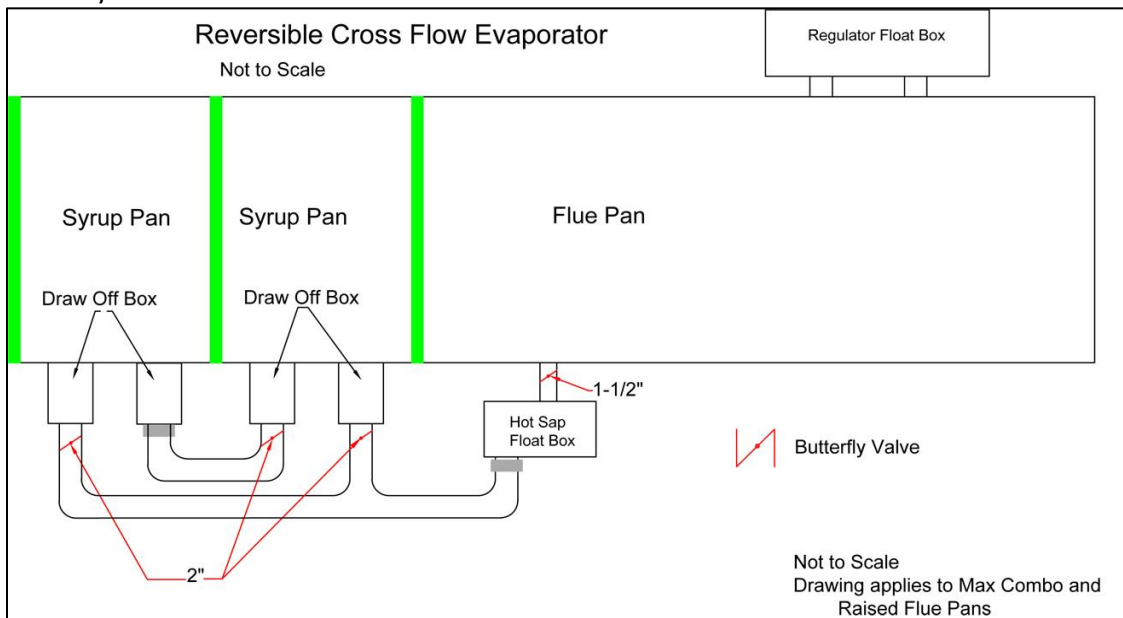

1. Disassemble the butterfly valve as follows:

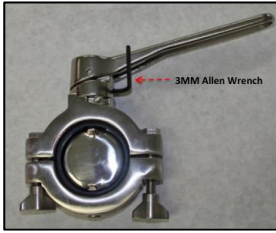

- a. Using the supplied 3MM Allen wrench, loosen and remove the handle.



- b. Loosen and remove the wing nuts and the bolts.

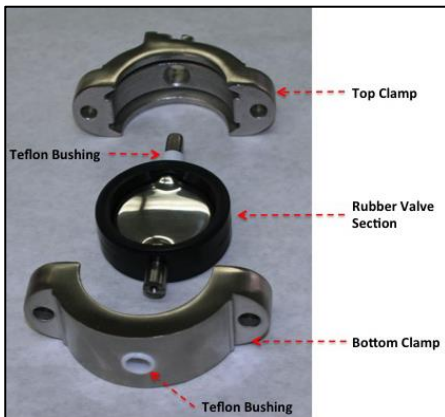

- c. Remove the top and bottom sections of the valve clamp. Note the Teflon bushings locations. Do not lose or damage these bushings.

2. Assemble the butterfly valve as follows:

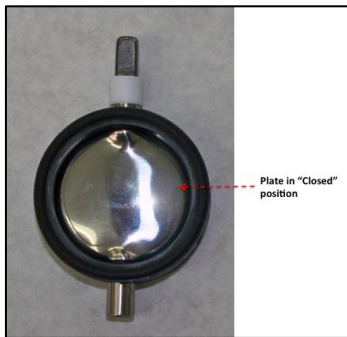

NOTE: To ease the step of aligning the handle to the valve, it is recommended during the installation steps, the valve remain in the "closed" position. The flat spot on the shaft is parallel to the valve plate.



- a. Place the rubber section between the ferrules to be connected with the handle end of the valve shaft so the handle will be positioned in its operating location.

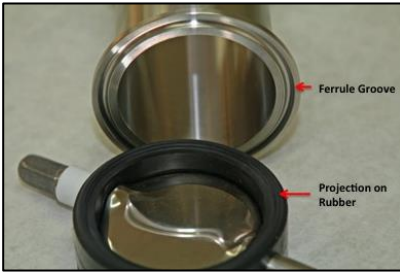

- b. Align the projections on the rubber valve section with the grooves in the ferrule. Ensure the Teflon bushing is on the “top” of the valve shaft.

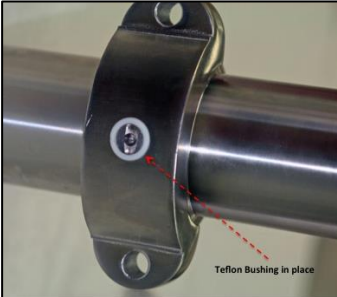

- c. Ensure the Teflon bushing is properly positioned in the bottom part of the valve clamp. Fit the valve clamp over the “bottom” shaft of the valve and confirm the Teflon bushing remains in place.



- d. Place the top part of the valve clamp over the “top” of the valve shaft, ensuring it is over the Teflon bushing.



- e. Insert the bolts with the bolt head on the same side as the top (handle side) of the valve and tighten with the wing nuts.



- f. Position the handle so it will be parallel to the valve plate (parallel to the valve body if it was installed in the closed position). Make sure the handle will be able to move to both the closed and open positions. Then tighten with the included 3MM Allen wrench.

Clamps With Teflon Seals

Clamp Locations:

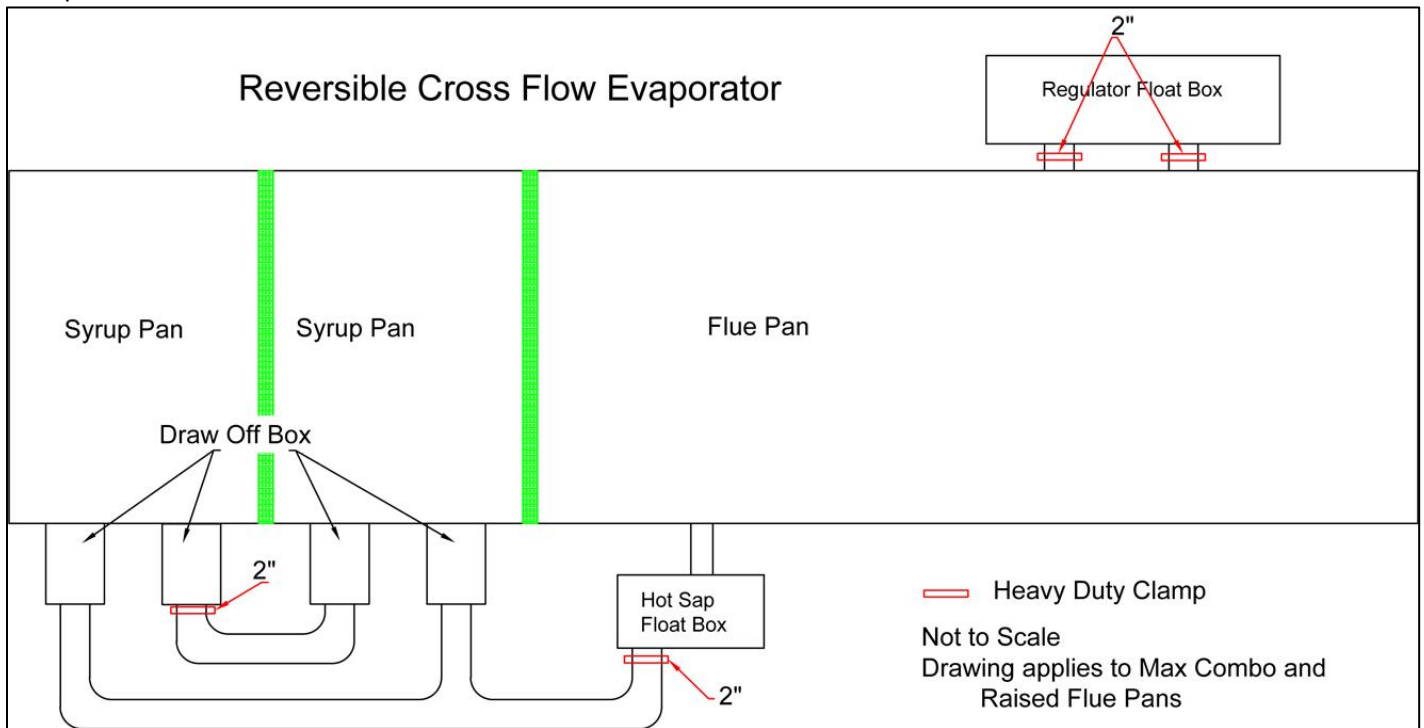

This section describes the use of Teflon gaskets, clamps and ferrules to make connections. The ferrules are welded in place to the items being connected. The Teflon gaskets and clamps are used as follows to complete the connections:

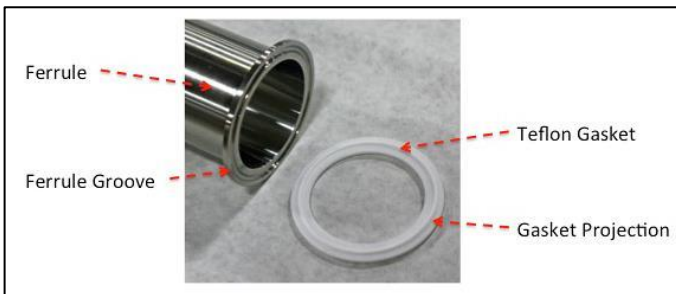

- a. Match the groove in the ferrule to the projection on the Teflon gasket.
- b. Place the clamp groove over the assembled ferrules and Teflon gasket. Ensure the gasket is properly seated in the ferrule prior to placing the clamp.

NOTE: The clamp does not rotate easily once placed over the ferrules. It is recommended you position the wing nut so it will be easy to access and will not be in a place where normal work is done.

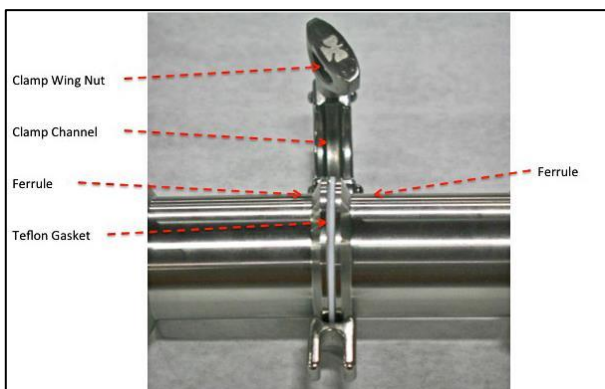

- c. Close the bolt of the clamp and tighten the wing nut.

Slip Fittings

Slip fittings are stainless steel couplers with O-ring seals at each end allowing for lengthening or shortening of the main connection pipe. This allows for an easier connection to the pan fittings.

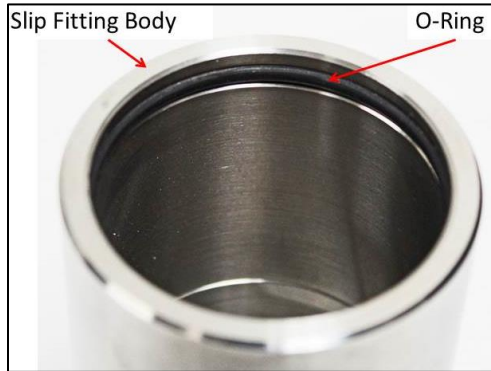

When using the slip fittings there are a number of items:

1. Each time the slip fitting is reconnected (slipped over) the main connection pipe, the O-ring should be lubricated with food grade grease.
2. When sliding the main connection pipe into the slip fittings, do it such that the pipes are aligned as best possible. This will prevent damage or dislodging of the O-ring.
3. Slide the fitting on the pipe joint so it overlaps each pipe approximately the same.

Preparing the Arch

Ensure the arch is in place, insulated and leveled prior to starting work with the pans. If you have a wood fired arch, dependent on the flue pan, as part of insulating the arch, you will need to prepare the baffles. The baffle is added to direct the heat up through the flue pan. This does not apply to a VORTEX arch.

Raised Flue Pan

1. The baffle(s) is installed at the Leader Evaporator factory for arches ordered with raised flue pans.

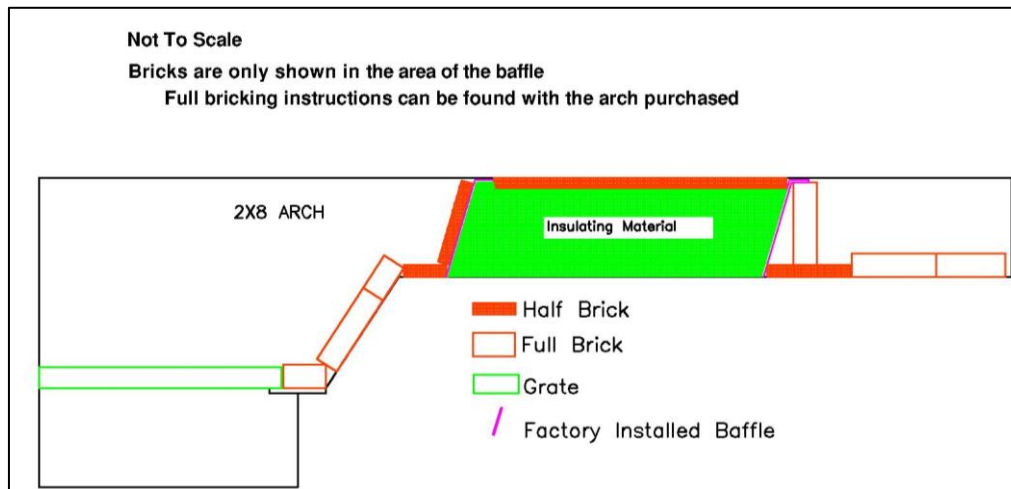

- a. Bricking of a 2 baffle arch is as shown in the illustration above.
2. Brick behind the grates and up the incline with full bricks as shown in the illustrations.
 3. Brick the baffle using a ½ brick as shown.
 4. For arches with two baffles
 - a. The first row of bricks on the floor behind the second baffle should be a ½ brick as shown.
 - b. Brick under the lip of the rear baffle by placing bricking a full brick upright under the lip of the rear baffle and standing on the half brick as shown.
 - c. Fill between the baffles with an insulating material such as vermiculite (Leader Order #65190) up to approximately 1 ¼" below the arch rail.
 - d. To prevent the insulating material from moving during operations, it needs to be secured. Cement half bricks or insulation board over the top of the insulating material covering the exposed area from rail to rail and from baffle to baffle.

For Max Combo Pans

1. A baffle is constructed by adding a row(s) of bricks at a certain point (or points) on the arch floor.

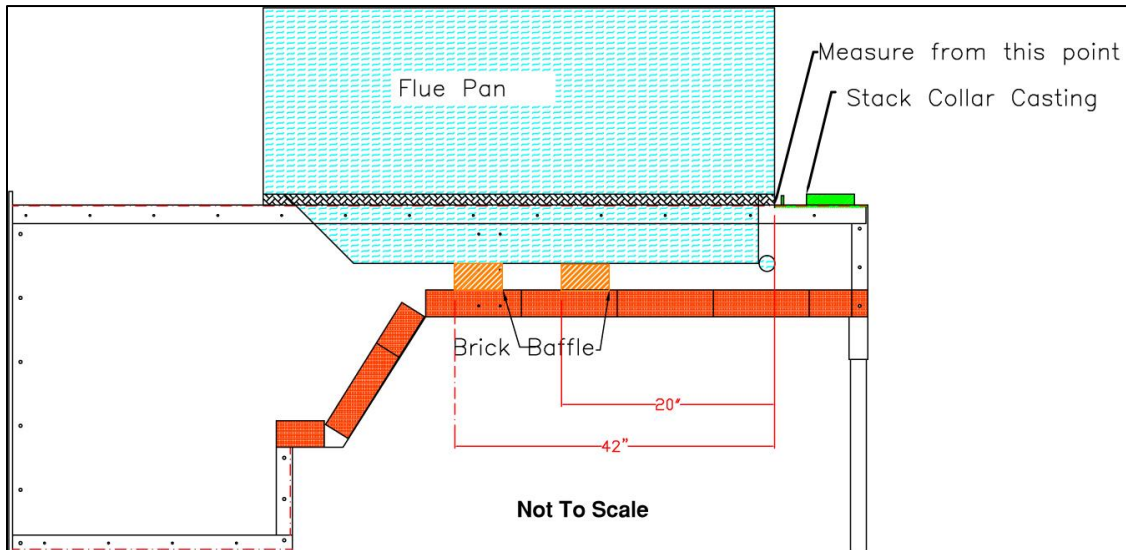

- a. The location of the baffle(s) is determined by measuring from the front of the arch collar casting as illustrated.

The table lists the baffle locations for different sized flue pans. The measurement should be taken from the front of the stack collar as indicated above to the front of the brick in the baffle.

Length of Flue Pan (ft.)	First Baffle Location (inches from front of casting)	Second Baffle Location (inches from front of casting)
5	20	42
6	20	54
7	20	66
8	20	78
9	20	90
10	20	102

2. The baffle should be constructed of either full or half bricks installed on the bricks on the floor of the arch. The height of the baffle should be to just under the bottom of the flues of the flue pan. When measuring where the flue pan flues will be, remember to include the thickness of the rail gasket you choose to use ($\frac{1}{4}$ " , $\frac{1}{2}$ " or 1").

Setting The Pans

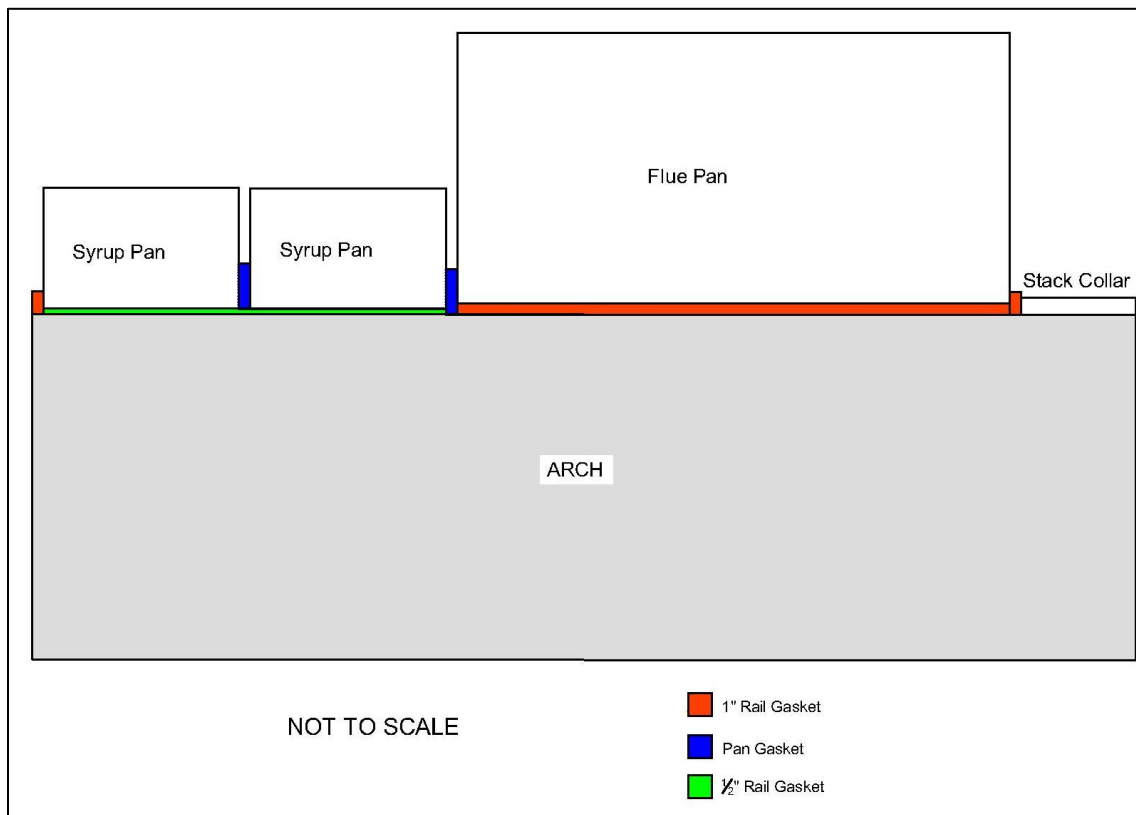

Placing the Flue Pan

1. The arch rail under the flue pan is to be lined with 1" rail gasket. Use a utility knife to cut pieces to fit.
2. The arch rail under the syrup pans is to be lined with 1/2" rail gasket. Use a utility knife to cut pieces to fit.
3. Cut a strip of 1" rail gasket the width of the flue pan + 4". Place it against the front of the stack collar-with 2" overlapping each rail. Tape the piece in place, if necessary.



4. Put the flue pan on the rail making sure the rail gasket stays in place. The rear of the flue pan will be the end closest to the side with the two welded ferrules. The flue pan should be tight against the rail gasket in front of the stack support. Remove the tape from the rail gasket if it was used.

Max Combo Flue Pan

1. Align the drain fitting in the pan with the hole provided in the arch.
2. Wrap Teflon tape around both ends of the provided 8" stainless steel nipple.
3. Insert one end of the wrapped nipple into the flue pan drain fitting and tighten.
4. Thread the stainless steel ball valve onto the other end of the 8" nipple. The handle should be pointed away from the arch when it is in the "open" position. Tighten the valve.

Installation of the Distribution Box and Pipe

If not previously installed follow the following steps to install the flue pan distributor pipe and distribution box:



1. Locate the feed pipe from the regulator float box of the flue pan.
2. Insert the distributor pipe into the flue box feed pipe. The distributor pipe should point toward the front of the arch. Let the pipe rest on the flues.

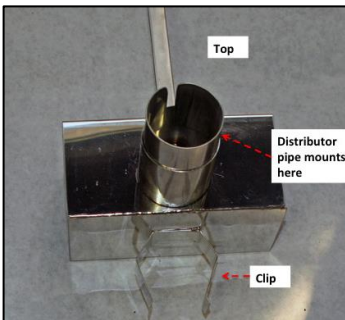

3. Slide the distribution box onto the open end of the distributor pipe. It should be positioned so the “clip” side will be down towards the flues.

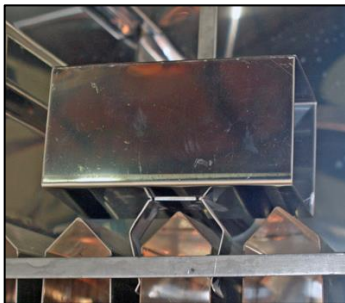

4. Keeping the distribution pipe as straight as possible, slip the clip over the flue to secure it in place.

Placing the Syrup Pans

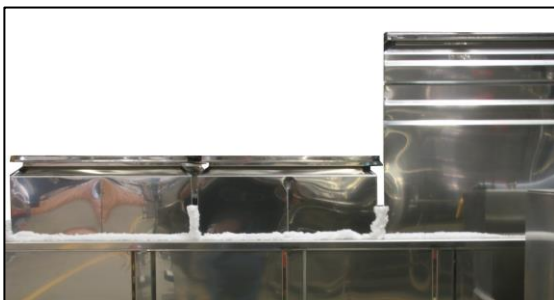

1. Cut pan gaskets to the width of the pan. Place one of the pan gaskets against the front of the flue pan using either a pan gasket holder (see Option Equipment) or tape to hold it in place.
2. Place one of the syrup pans on the rails of the arch as close to the flue pan as possible, compressing the pan gasket. The syrup pan should be positioned so the draw off boxes are on the same side of the arch as the hot sap float box.

3. Place a pan gasket against the front of the syrup pan already in place and use either a pan gasket holder or tape to hold it in place. Place the second syrup pan against the pan gasket with the draw off boxes on the same side of the arch as the hot sap float box. Repeat this step if a third pan is to be added.
4. Place a piece of 1" rail gasket 4" wider than the syrup pan, in front of the syrup pan to cover the opening between the syrup pan and the arch. Remove tape from the pan gasket, if it was used.

Float Box Installation

In the following sections you will be installing the float boxes and connections controlling the flow of sap through the evaporator. The following illustration indicates an example of the locations of these boxes. Note the actual locations of the boxes will vary dependent on the functional locations you ordered. The illustration shows a left feed, right draw set of pans. If you had ordered a left feed, left draw set of pans all the boxes (regulator and hot sap) would be on the left side.

NOTE: When the box installation is complete, the boxes should be as level as possible.

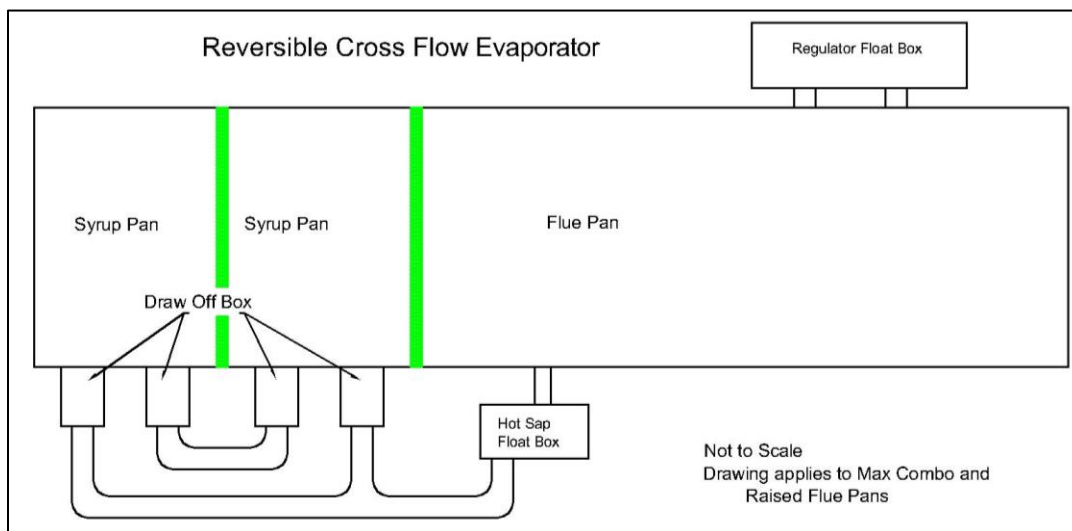

Regulator Float Box

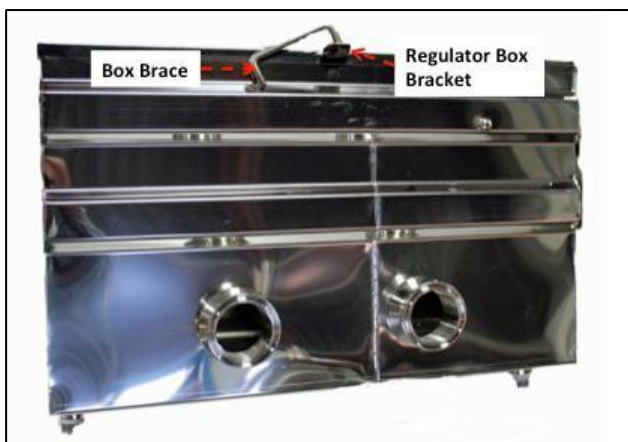

1. Insert a box brace into the regulator float box until the flat end of the brace is under the box bracket.
2. Line up the regulator float box ferrules to the ferrules at the rear of the flue pan. Hook the loose end of the box brace into the bracket on the flue pan, above the ferrules.

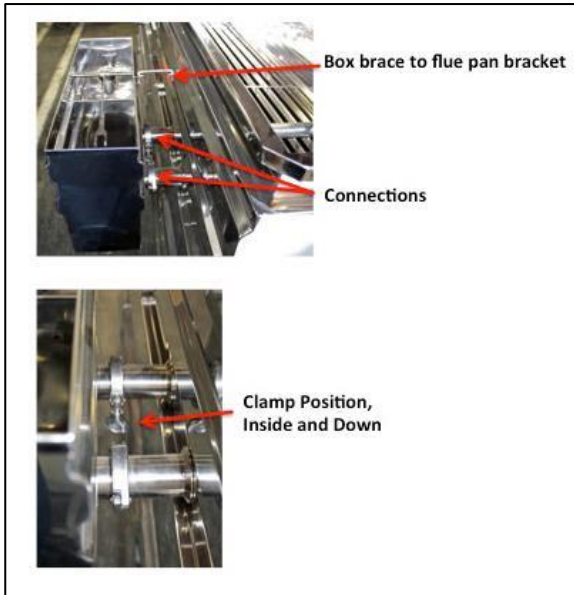

3. Place a 2" Teflon gasket between each set of ferrules. Put pressure on the float box to hold the gaskets in place then secure the connections with 2" heavy duty clamps.

Hot Sap Box

NOTE: To ease assembly, place all parts within reach (or have a second set of hands to help).



1. Disassemble a 1 ½" butterfly valve.
2. Place the rubber section of the 1 ½" butterfly valve against the front ferrule of the flue pan. Orient the hand end toward the rear of the flue pan.
3. Place the hot sap box against the other side of the rubber section of the butterfly valve ensuring the ferrule is correctly lined up with the rubber section.
4. Place the handle on the butterfly valve stem and tighten with the included 3MM Allen wrench.

Installation of the Draw Off Valves

Pans Sets Width up to and including 30"

Pan sets with a width of 30" or less have female threaded connections for draw off valves under the draw off boxes.



1. Teflon tape both ends of four 1" stainless steel close nipples.
2. Thread a Teflon taped stainless steel close nipple into each of 4 - 1" stainless steel ball valves. The handle of the ball valve in the "open" position should be on the opposite side as the close nipple.

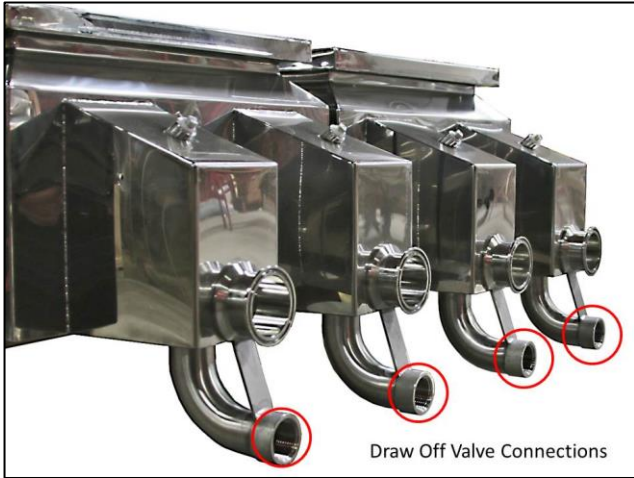

3. The draw off valves are to be installed in the connections as identified in the picture at the right.

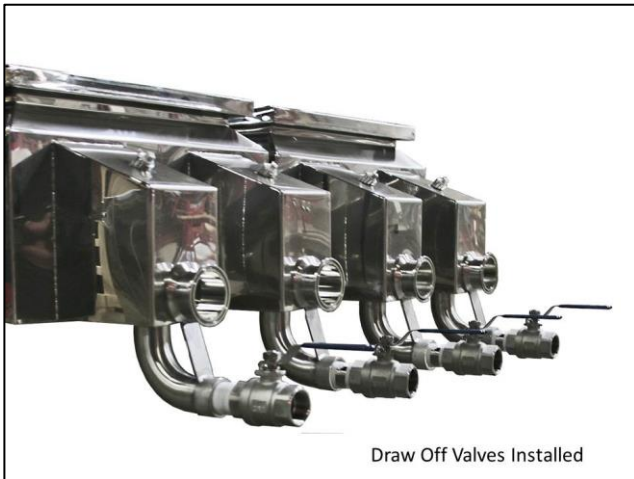

4. Thread the Teflon taped end of the ball valve / close nipple assembly into each of the connections. The handles of the valves should point away from the pans. Tighten the assembly into the connection with the valve handle being positioned for ease of use.

Pan sets 40" and 48" in Width

Pan sets of width 40" or 48" width are supplied with flanged couplers for draw off valves under the draw off boxes.

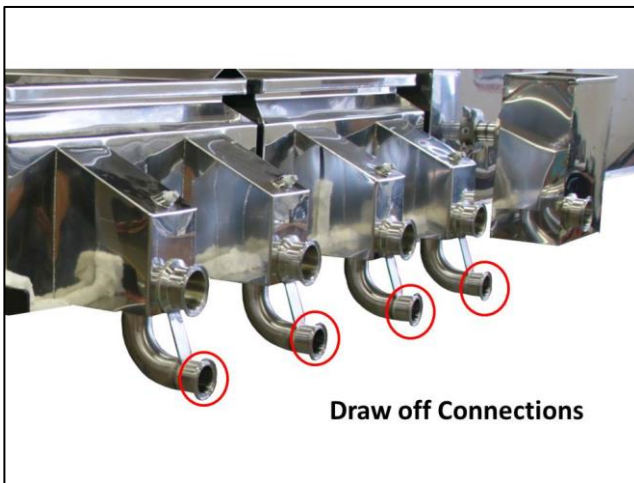

1. Locate the draw off connections below the draw off boxes of the syrup pans.



2. Teflon tape the threaded ends of the four 1 ½" adapters.



3. Thread a 1" stainless steel ball valve onto each of the Teflon taped adapters.



4. Teflon tape the threaded end of the two supplied draw off nozzles. Thread the nozzles into the each of the two center ball valves and tighten.



5. Teflon tape the threaded end of the two (2) 1' threaded to 1 1/2" clampable adapters. Thread the adapters into the outer stainless steel ball valves and tighten.

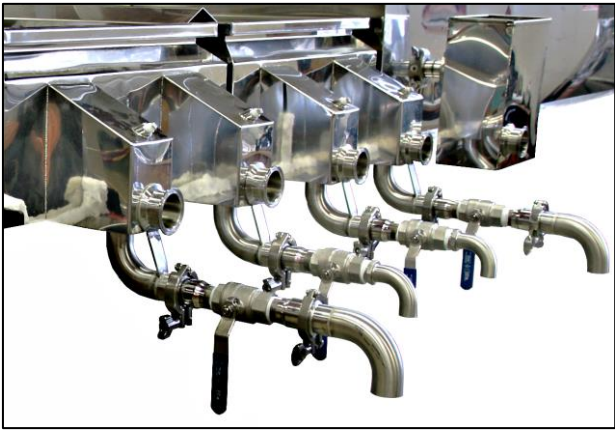

6. Using 1 1/2" clamps with Teflon seals, secure a 1 1/2" nozzle to each of the adapters installed in the previous step. Ensure the nozzle openings are pointed vertically down.

Pan Sets 5 and 6 Foot



1. Five (5) and six (6) foot wide syrup pans are supplied with 2" clampable fittings for the draw off installation.



2. Secure a 2" draw off nozzle to each of the clampable fittings using a 2" butterfly valve. Ensure the handles will work freely and the nozzles are vertical.

Installation of the Connecting pipes

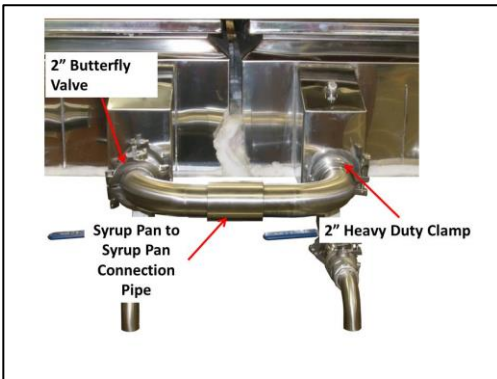

1. Connect the two (2) syrup pans using the syrup pan connection pipe and a 2" heavy duty Teflon gasketed clamp and a 2" butterfly valve. Install the butterfly valve on the draw off box closest to the flue pan.

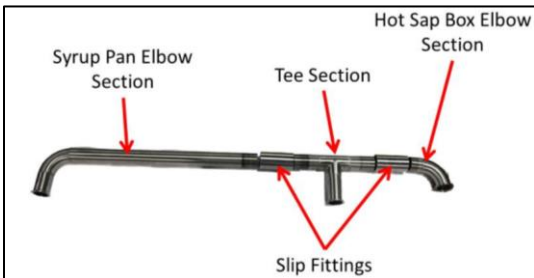

CONNECTION PIPE DETAIL

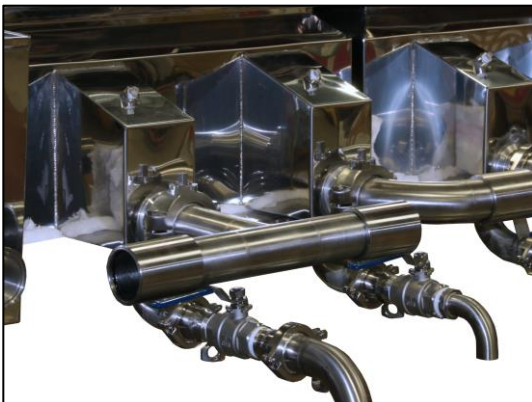

2. Lubricate the o-rings of the two (2) slip fittings using a food grade lubricant such as Leader Evaporator part number 55095. Slide one onto each end of the supplied tee pipe. Using a butterfly valve, secure the pipe to the draw off box closest to the flue pan.

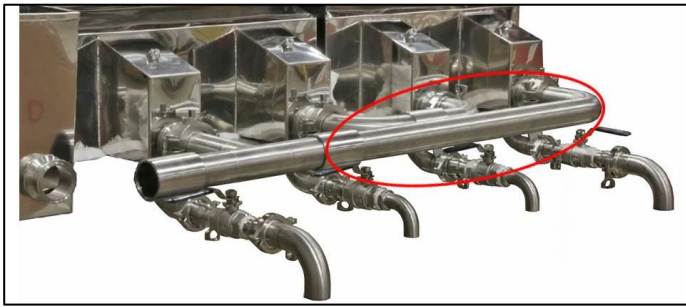

3. Insert the long curved end pipe into the front slide fitting on the tee. Turn the clampable end to point to the clampable fitting on the front draw off box. Adjust the position of the pipe to align the fittings by sliding the pipe in the slip fitting. Secure the pipe to the draw off box using a 2" butterfly valve. Ensure the slip fitting is secure to both pipes.



4. Insert the non flanged end of the short curved pipe into the slip fitting of the tee. Turn the clampable end to point to the clampable fitting on the flue pan regulator box. Adjust the position of the pipe to align the fittings by sliding the pipe in the slip fitting. Secure the pipe to the regulator box using a 2" heavy duty clamp. Ensure the slip fitting is secure in both pipes.

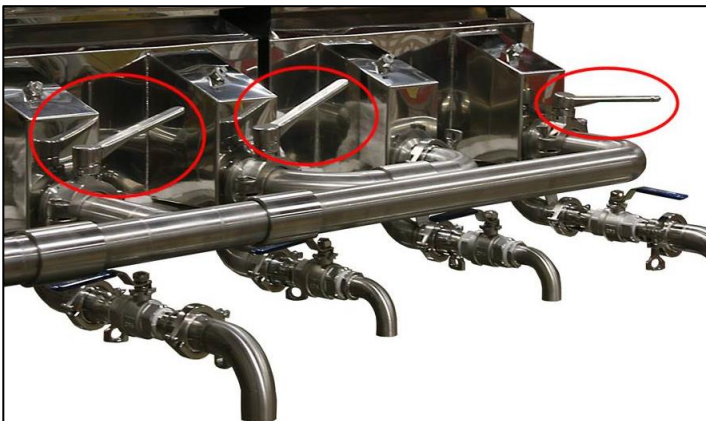

5. Put the handles on the valves and tighten the set screws with the included 3MM Allen wrench.

Installation of the Regulator Floats

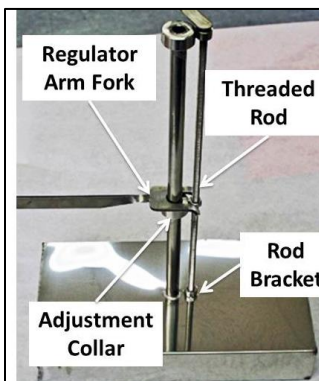

1. Insert the regulator float into the regulator float box. Do not force the regulator arm. The following is one method of inserting the float

NOTE: The float should always be positioned so the stem is facing the fork of the regulator arm and the threaded adjustment rod is at the open end of the fork. When the float stem has been positioned under the regulator fork, ensure the adjustment collar is under the fork and the threaded rod is seated in the bracket on the float.



2. Turn the adjustment lever until the collar is approximately in the middle of the float rod.



3. Begin inserting the float into the float box while holding up the regulator arm. The float should be angled slightly toward the outside of the float box (away from the flue pan) and lengthwise on end to be able to slide under the regulator arm. The regulator arm will be on the flue pan side of the float stem.



4. Continue to turn the float downward and under the regulator arm until the float is resting on the bottom of the float box. The regulator arm will be on the side of the float stem.



5. Turn the float toward the rear of the float box until the regulator fork will slide around the float stem over the collar. Lower the float back to the bottom of the float box.

6. Insert the hot sap float into the hot sap box.

Parts of the float

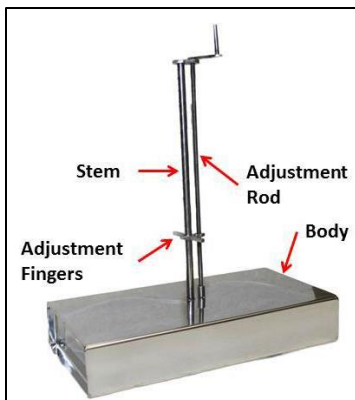

- a. If already installed remove the Z-arm by lifting out of the bracket mounted to the side of the sap box.
- b. Holding the float by the stem and the body, tilt it and carefully lower it into the sap box. It will rest under the pipe from the flue pan. The stem (not the adjustment rod) should be toward the rear of the sap box.

c. Install the Z-arm

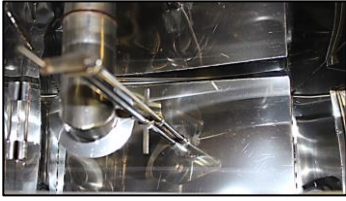

- i. Turn the adjuster until the fingers are approximately 2" from the top of the float.
- ii. Tilt the float toward the front and outside of the sap box.
- iii. Position the Z-arm so the forked end points toward the front of the sap box and is on the side of the float stem closest to the flue pan.
- iv. Tilt the Z-arm toward the flue pan and slip the end into the bracket on the back side of the sap box.
- v. Tilt the float toward the front of the sap box and slip the stem between the forks. The adjustment fingers of the adjustment rod should be below the Z-arm fork.

Completing the Pan Setup

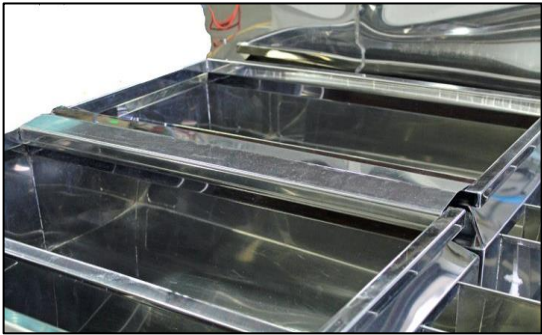

1. Install the syrup pan joint cover by slipping the long edges of the cover inside the edges of the front and rear syrup pans.



2. Connect the raw sap feed to the flue pan regulator box. The bottom of the feed source should be a minimum of 3 to 6 inches above the top of the regulator box. It is recommended a shutoff valve be installed between the sap source and the regulator box. The following is a recommended method of attaching the sap source to the regulator box. NOTE: The parts listed for this connection are not included with the pans.
 - a. Teflon tape:
 - i. two 1 1/4" stainless steel close nipples
 - ii. 1/2" stainless steel close nipple
 - iii. 1 1/4" to 1/2" stainless steel reducing bushing



- b. Thread one end of a 1 1/4" close nipple into the threaded coupler on the end of the regulator box.



- c. Thread the 1 1/4" stainless steel tee onto the stainless steel nipple and tighten until the open ends are straight up and down.



- d. Thread a 1 1/4" to 1/2" stainless steel adapter into the bottom of the tee.



- e. Thread the 1/2" stainless steel close nipple into the 1/2" stainless steel ball valve.

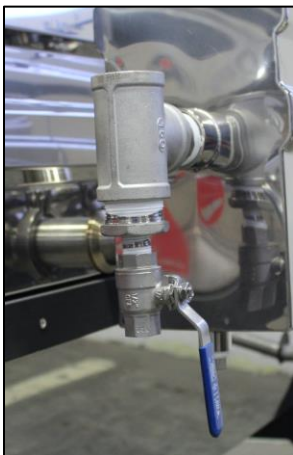

- f. Thread the 1/2" stainless steel ball valve and nipple assembly into the adapter in the bottom of the tee and tighten all parts into the tee (adapter, nipple and ball valve). . Make sure the handle of the ball valve can operate without interference.



- g. Thread a Teflon taped 1 1/4" stainless steel close nipple into the 1 1/4" stainless steel ball valve.

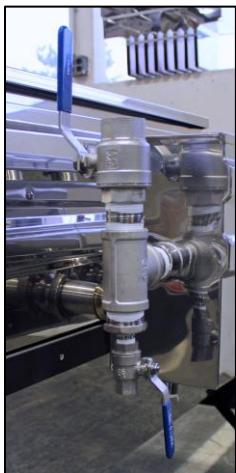

- h. Thread the taped end of the 1 ¼” stainless steel nipple (on the stainless steel ball valve) into the top of the stainless steel tee.
- i. Tighten the parts (ball valve, close nipple) into the tee. Make sure the handle of the ball valve can operate without interference.
- j. Connect the sap source tank to the upper ball valve. The bottom of the sap source tank needs to be a minimum of 6” above the top of the evaporator. Additional height will be needed if a Steam-Away or a preheater are installed. Connections can be made between the sap source tank and the evaporator using PVC or other plumbing approved for potable water.

3. All parts have now been installed for the pans. Check to ensure the following connections are properly installed and tight.
 - a. 2 heavy duty clamps between the regulator box and the flue pan
 - b. 3 butterfly valves and the heavy duty clamp on the flue pan to syrup pan connection pipe
 - c. The butterfly valve between the hot sap box and the flue pan
 - d. 1 heavy duty clamps on the syrup pan to syrup pan connection pipe

Position the valves as follows:

- a. Ball valves on the draw-off boxes - CLOSED
- b. Butterfly valve between the hot sap box and the flue pan - OPEN
- c. 3 butterfly valves on the syrup pans – OPEN
- d. Flue pan drain valve – CLOSED
- e. Cold sap regulator box feed drain valve, if installed – CLOSED

FIRST PAN CLEANING:

NOTES:

- Only Leader Evaporator approved chemicals are to be used in operations and maintenance.
- Ensure after use no chemical residue remains on items such as rail gaskets or pan gaskets.

CAUTION: Whenever the arch is heated the exposed piping will be hot.

1. To perform the initial cleaning you will need baking soda and water solution. It is mixed with non-chlorinated water at the rate of 1 pound per 200 gallons. The depth to be used in the calculations will be 2" to 3" as determined by user.

NOTE: Have enough unsoftened, non-chlorinated well or spring water available to replenish the liquid levels in the pan. The volume needed can be approximated by checking the evaporation rate of your evaporator.

2. Close the ball valves on the syrup pan draw off boxes.
3. Open the butterfly valves on the syrup pans.
4. Mix the baking soda and the water to be used.
5. Begin adding water/baking soda solution to the flue pan. As the flue pan fills the liquid will flow through to fill the syrup pans.
6. When the solution is 2" to 3" above the tops of the flues in the flue pan and 2" to 3" in the syrup pan, stop adding the solution. The fluid level is set by adjusting the float for each of the pans.
7. Fire the arch until the water/baking soda solution has boiled for 30 minutes. WATCH CAREFULLY AS THE PANS CANNOT BE ALLOWED TO BOIL DRY AND THE FLUE AND SYRUP PAN LIQUID LEVELS SHOULD BE KEPT AT 2" TO 3". MAINTAIN LEVELS WITH UNSOFTENED, NON CHLORINATED WELL OR SPRING WATER.
8. Cool the arch until there is no more boil in either pan and the fire is down to coals on the grates (in a wood fired arch) then drain the solution.
 - a. To drain the flue pan, open the ball valve on the side of the arch opposite the regulator float box. Unless ordered otherwise the valve will be located on the right side of the flue pan.
 - b. Drain the syrup pans by opening the draw off valves under the draw-off boxes. The syrup pans can be lifted approximately 2" on the side opposite the draw off boxes to aid in the draining. Use caution so as not to break fittings.
9. Repeat steps 2 through 9 using just clean unsoftened, non-chlorinated well or spring water.
10. Open all the drains and flush the pans with clean unsoftened, non-chlorinated well or spring water until the draining water is clear.

THEORY OF OPERATION

A maple syrup evaporator works under the principle of a gradient. As the sap boils, it concentrates. As it concentrates, the volume is reduced and the solids (sugar concentration) increase. As the volume is reduced the liquid works to maintain the levels across the evaporator so less concentrated sap flows into areas where there is more concentrated sap. During the evaporation process the percent of sugar will change from the incoming (approximately 2%) to the draw off (approximately 66%). The design of the LEADER Cross-Flow pan set, through the use of a few valves, makes it easier to maintain the gradient while changing the direction of the flow in the syrup pans.

Forming The Gradient

When the evaporator is first filled, the concentration of the sap is the same throughout. The gradient is formed as the water is evaporated from the sap in the syrup pan and the flue pan, and as the new sap enters the flue pan.

As the sap boils it loses moisture and becomes denser. As it is becoming denser it loses volume. As it loses volume additional sap will try to keep the levels constant and at the same concentration. This is occurring in both the flue pan and the syrup pan.

In the flue pan less concentrated sap enters through the regulator box into the first flue pan chamber and begins to concentrate. As it concentrates it moves toward the second chamber of the flue pan. Early in the boil the second chamber will become denser as the “fresh” sap is entering the first chamber from the regulator box keeping it less concentrated.

As the syrup pan boils, the sap becomes denser. In a 2 float system (one float controlling the level in the flue pan and one float controlling the level in the syrup pan), the hot sap box lets sap from the flue pan enter the syrup pan when the sap level concentrates and drops. The sap from the first syrup pan chamber is pushed to each of the next syrup pan chambers where the sap is denser until it reaches the “syrup” or “draw-off” chamber. The syrup is drawn off the evaporator and more sap flows across all the chambers to replace the volume drawn off.

With a good gradient in place there will be a measureable difference in the liquid levels between incoming sap side of the syrup pan and the syrup side. You may note a difference of up to ½”.

Proper Operations To Maintain The Gradient

- Firing
- Defoamer
- Minimize Reversal Effects

During operations you will be working to maintain a consistent gradient. This is done through firing level, control of foaming, and minimizing the effects of reversal.

Firing

During firing you are seeking to maintain the same boil all the time. By doing so the liquid “push” in the pans will remain consistent. If the boil reduces the flows will not be maintained and the gradient lost. In order to maintain the boil the following should be of concern – when burning wood:

1. Wood to use
 - a. Mix of hardwood (longer lasting, more BTUs) and softwood (quicker, intense heat).
 - b. Avoid slabs as they do not allow heat to evenly reach the pan
 - c. Split wood 2” to 3” in diameter and approximately the length of the firebox of the arch.
2. Loading wood into the arch
 - a. Wood should stay on the grates and 2” to 5” inside from the door so wood fire does not heat the arch face
 - b. Criss-cross the wood as best possible so oxygen can reach all wood efficiently
 - c. Do not hit flues when loading wood

3. When using a wood fired arch
 - a. Keep stack temperature in range of 650°F to 800°F
 - b. Maintain arch ½ to ⅔ full
 - c. Fire consistently with small amounts of wood to maintain level
 - d. Use timer to stay on schedule with firings
 - e. Adjust firing intervals as needed to maintain an even boil

Defoamer

The purpose of defoamer is to prevent foam build up in the pans. Foam build up will prevent proper evaporation of the water from the sap. It will give a false liquid level to the float and will not allow the incoming sap to flow in a consistent manner. Inconsistent defoamer usage will create large volume adds of sap into the pans as the foam is reduced and the float seeks to replace the level with incoming sap. The following items should be of concern in the use of defoamer:

1. Use defoamer on a regular basis. It is suggested you add defoamer to the flue pan near where the sap is entering each time you fire the evaporator.
2. Add defoamer primarily to the flue pan. Modify this only under certain conditions
3. Proper add is dependent on the width of the evaporator and is recommended as follows: NOTE: This is based on the use of ATMOS 300 Defoamer

Pan Set Width (Inches)	Drops of Defoamer
24	3
30	4
36	4 to 5
40	5 to 6
48	6 to 8
60	7 to 9
72	8 to 11

4. NEVER add defoamer to the center compartments of the syrup pan. Use one drop at a time in the syrup compartment near the draw off box.

Minimize Reversal Effects

Reversal occurs when the boil in the evaporator is reduced (when firing is inconsistent, end of day, change pan flow direction).

To minimize this effect:

1. Maintain a consistent boil even during reversal.
2. After the last syrup draw of the day, draw “sweet” from the syrup pan into a clean container. This will be added to the syrup pan at the beginning of the next boil and aid in setting up the gradient.

NOTE: Adding “sweet” to the draw off compartment of the syrup pan will raise the concentration in that compartment shortening the time it will take to reestablish the gradient.

OPERATING THE EVAPORATOR

NOTE: You must be aware at all times of the level of sap in all compartments of the pans. If the level drops too low you can and will damage your pans. If there is too much foam you risk damaging your pans.

NOTE: If you have purchased a scoop or skimmer, do NOT use them to push sap through the evaporator. Doing so will change the gradient in the evaporator.

CAUTION: Whenever the arch is heated the exposed piping will be hot.

Check The Evaporator

1. Check the evaporator
 - a. Make sure all sap sources are flowing i.e. not frozen
 - b. Ensure defoamer is usable
 - c. Ensure all fittings are tight
 - d. Make sure all valves are working properly and the floats are in position
 - e. Wood Fired Arch - Clean the flues with the flue brush (standard wood fired arch – daily, INFERNO arch – weekly)
 - f. Ensure the open area in the grates is clean and free of material
 - g. Open stack cover(s), cupola and thimbles.
 - h. Open hood condensate drains.

Reversal of Syrup Pans

1. If this startup is for a new evaporator or for the first time of the season, skip to the next numbered paragraph.

It is recommended in order to minimize the sugar sand and niter, the flow in the syrup pan be reversed daily or when it is noted the bubbles from boiling are drawn back down into the compartment as they break (appear like boiling mud). The following are the instructions for reversing the flow of the syrup pans. Switching sides on reversible cross flow pan set involves collecting partially boiled sap and the control of 2 valves.

- a. Draw “sweet” from the draw off box of the current “finishing” syrup pan and set aside.

GALLONS OF “SWEET” FOR A REVERSAL DRAW-OFF

PAN WIDTH	Suggested Minimum Gallons "SWEET"
24	1
30	2
36	2
40	3
48	5
60	10
72	10

These are suggested quantities. The amount should be adjusted with experience, based on the width of the pan and the concentration of sap being used.

- b. Identify which valves are currently open, what the current sap flow is, and match to the chart below

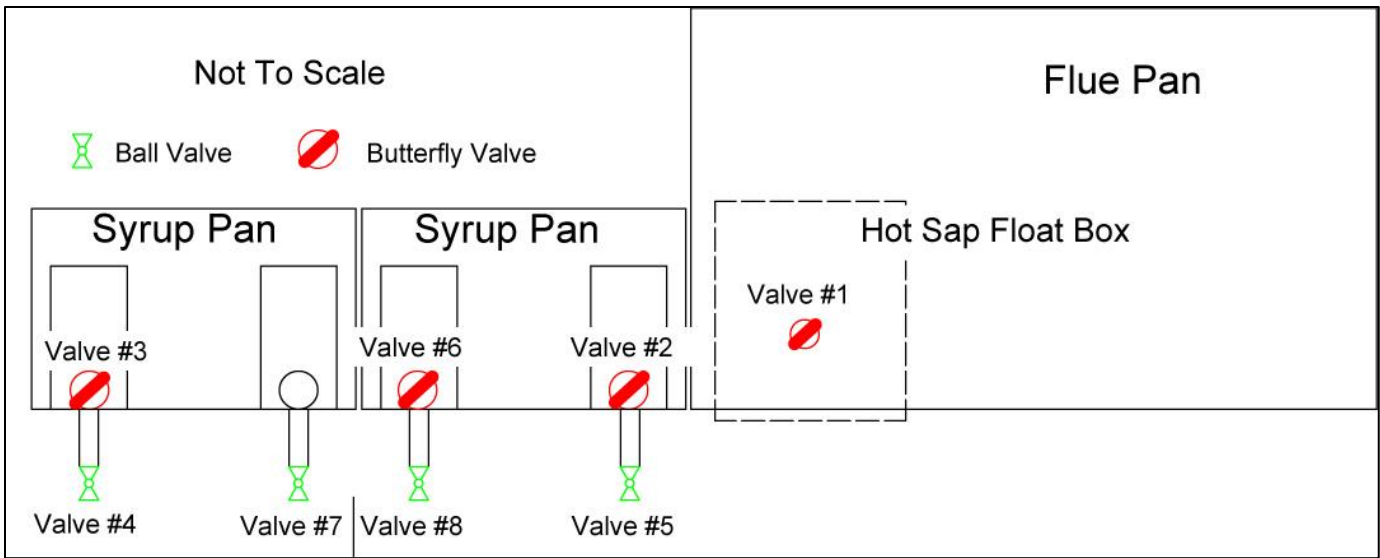

Flow Direction	Valve 1	Valve 2	Valve 3	Valve 4	Valve 5	Valve 6	Valve 7	Valve 8
REAR DRAW Rear syrup pan is finishing pan	Open	Closed	Open	Closed	Draw Off	Open	Closed	Closed
FRONT DRAW Front syrup pan is finishing pan	Open	Open	Closed	Draw Off	Closed	Open	Closed	Closed

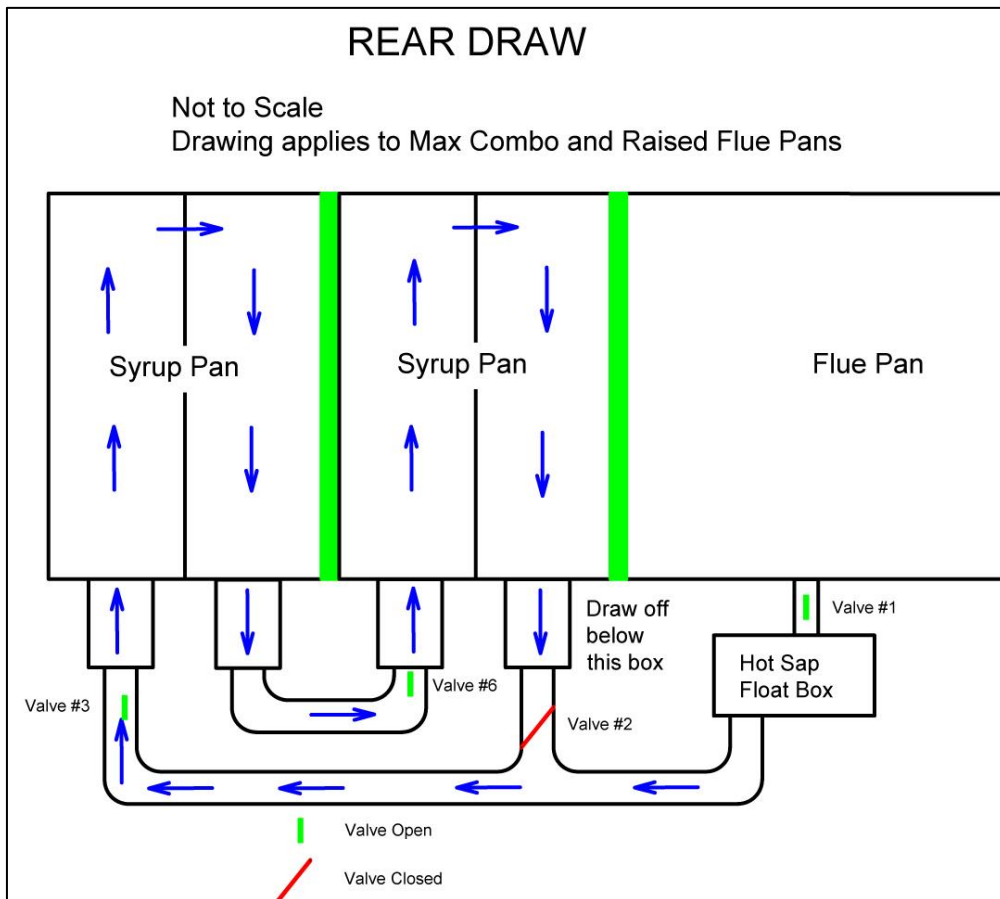

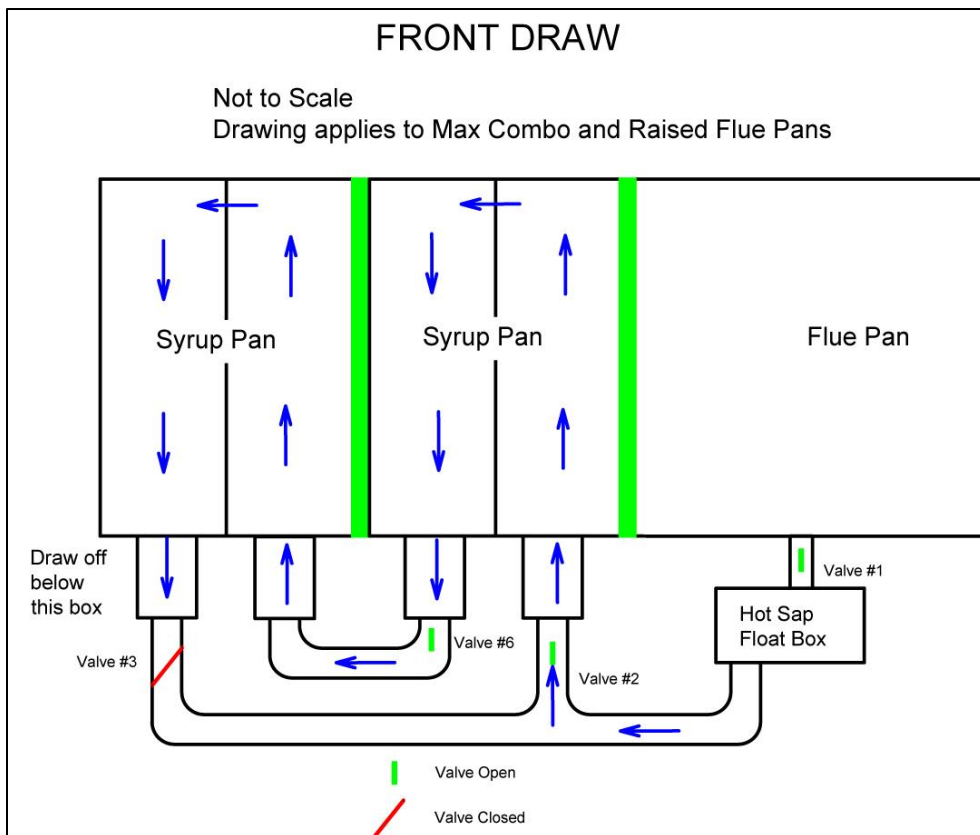

- c. On the connection pipe from the flue pan, close the open valve (either valve #2 or valve #3). Valve #1 (between the hot sap pan and the flue pan) remains open and does not change.
- d. Open the valve on the connection pipe that had been closed (valve #2 if valve #3 had been open, valve #3 if valve #2 had been open).
- e. For a beginning of day start, when the middle of the syrup pan reaches a boil, slowly add the “sweet” to the syrup compartment of the syrup pan.
 - i. If you opened valve #2 (closed valve #3), pour the “sweet” into the front compartment of the front syrup pan.
 - ii. If you opened valve #3 (closed valve #2), pour the “sweet” into the rear compartment of the rear syrup pan.
- f. If doing a mid-day (mid cycle) reversal, maintain an even fire throughout the process adding the “sweet” to the new draw off compartment at the completion of the syrup pan plug valve changes.
 - i. If you opened valve #2, pour the “sweet” into the front compartment of the front syrup pan.
 - ii. If you opened valve #3, pour the “sweet” into the rear compartment of the rear syrup pan.

Making Syrup

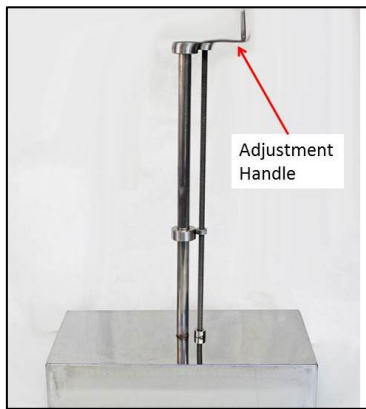

1. Open the valve between the sap source and the regulator float box. Adjust the float in the regulator float box so the sap level is over the flues about 1". To set the depth using the float, turn the adjustment handle on the threaded rod counterclockwise to raise the sap level and clockwise to lower the sap level.



2. Open valve #1 which is located between the flue pan and the hot sap box. Make sure the level of sap in the syrup pans is at least 1 1/2". The level in the syrup pans should be adjusted for the type of sap being run and the size of the pan. The higher the concentration of the sap (ex. From an RO) and the larger the pan, the deeper the syrup should be run. The level of the sap is adjusted using the float in the hot sap box.

NOTE: The following tables should be considered guidelines and actuals levels should be adjusted to your boiling style.

ARCH	Standard Draft		Forced air or Oil fired		Steam-Away or Preheater with hood		Reverse Osmosis	
	Flue Pan Depth (inches)	Syrup Pan Depth (inches)	Flue Pan Depth (inches)	Syrup Pan Depth (inches)	Flue Pan Depth (inches)	Syrup Pan Depth (inches)	Flue Pan Depth (inches)	Syrup Pan Depth (inches)
2X6 to 3X10	¾	1 ½	No change	Add ¼	Add ¼	Add ¼	Add ¼	Add ½
3X12 to 4X14	1	1 ¾	No Change	Add ¼	Add ¼	Add ¼	Add ¼	Add ½
5X14 to 6X16	1 ¼	2	No Change	Add ¼	Add ¼	Add ¼	Add ¼	Add ½

NOTE: As you add enhancements to the evaporator, add the additional depth as specified for that enhancement. For example adding an RO to a 4X10 standard draft evaporator would bring the recommended depth for the flue pan to 1 ¼" and the depth for the syrup pan to 2 ¼".

3. If this is a new pan set startup or the first startup of the season, open butterfly valve #2, close butterfly valve #3 and ball valves #4 and #5. Otherwise change the valves in use as outlined in the paragraph describing reversal of the syrup pans.

4. Using the directions provided with the arch, fire the evaporator.

Pan Set Width (Inches)	Drops of Defoamer
24	3
30	4
36	4 to 5
40	5 to 6
48	6 to 8
60	7 to 9
72	8 to 11

5. As the flue pan starts to boil, add defoamer (based on ATMOS 300) to the flue pan on the side where the fresh sap is entering. Defoamer should be added close to the inlet from the float box. During boiling add defoamer every 5 to 10 minutes or each time the arch is fired. Adjust the time as necessary to control the foam.

NOTE: If a Reverse Osmosis unit is in use, increase the defoamer use by one drop per foot width of the evaporator

6. If this is the first boil of the season or “sweet” was not saved from a previous boil, skip to the next section.
- As the middle of the syrup pan starts to boil, add the “sweet” to the draw-off compartment of the syrup pan. If you opened valve #2, pour the “sweet” into the front compartment of the front syrup pan. If you opened valve #3, pour the “sweet” into the rear compartment of the rear syrup pan.
5. As the syrup pan is boiling, watch for foam higher than the compartment dividers of the syrup pans. If the foam is higher than the dividers, add 1 to 2 drops of defoamer to the flue pan. It will take 15 to 20 minutes before any change is noted. If these additions of defoamer do not control the foaming, add 1 to 2 drops of defoamer to the draw-off compartment of the syrup pan. The addition should be done at the end of the syrup pan where the draw off is located. Add an additional 1 to 2 drops to the flue pan if the foam has not been controlled. REMEMBER you are trying to stop the foaming not the boiling. If foaming persists (adds of defoamer to the syrup pan are needed 2 or 3 times an hour) increase the defoamer added to the flue pan by 1 or 2 drops at each firing.
7. The sap in the syrup compartment of the syrup pans must be boiled until it reaches 7.0°F to 7.5°F above the boiling point of water (the draw off temperature). The boiling point of water is not a consistent point. Therefore the following is the recommended method for determining the draw-off temperature.

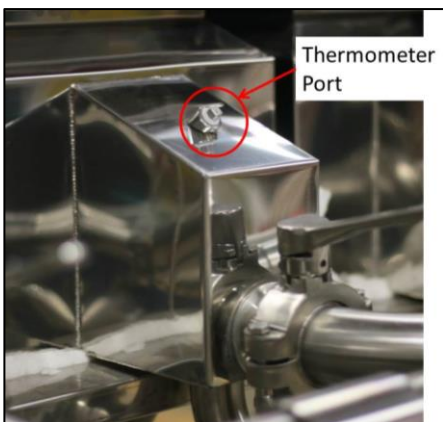

- a. Prior to using the evaporator, install a thermometer in the syrup pan in the ¼” threaded fitting. The locations for the thermometer fittings are above the draw off boxes of the syrup pans. You will need to use a thermometer with a 9” stem (Leader order #61025 for a 3” face or 61031 for a 5” face) in the front draw off box of the front syrup pan and the rear draw off box of the rear syrup pan. As an option to a thermometer, a Leader Smart Draw can be installed in the draw off compartment.
- b. As the sap begins boiling in the syrup pan, monitor the thermometer. The thermometer needle will need to go around completely once and come back to the “7” mark on the thermometer
- d. Adjust the thermometer to “7” when the hydrometer indicates the sap in the pan has turned to syrup. To adjust the thermometer, place the Allen wrench, provided with the thermometer, into the screw and turn until the “7” aligns with the needle.

8. Position the container being used to hold the finished syrup under the draw off valve.
 - a. If valve #3 is open the draw-off valve will be valve #5.
 - b. If valve #2 is open then the draw-off will be valve #4.
9. Open the draw-off valve and allow the syrup to flow slowly, maintaining the temperature at the “7” mark as long as possible. When the temperature starts to drop below the “7” mark, close the draw off valve.
10. Constantly check your incoming sap, at the regulator float box to ensure it is flowing properly.

Daily Shutdown

Wood Fired

1. There are two factors influencing the shutdown of the evaporator; time and sap volume.
 - a. It will require approximately 30 minutes to 1 hour from the last firing to bring the fire down to embers (coals on the grates) in a wood fired arch.
 - b. It will require a volume of sap from the last firing to embers and to flood the arch so ensure there is adequate volume left prior to the last firing.
2. After the last draw off and last firing draw-off “sweet”, from the evaporator into a clean container. Set the container aside and cover it. The table below indicates suggested quantities for draw.

PAN WIDTH	Suggested Minimum Gallons "SWEET"
24	1
30	2
36	2
40	3
48	5
60	10
72	10

These are suggested quantities. The amount should be adjusted with experience, the width of the pan and the concentration of sap being used.

3. Continue to monitor the arch as done for normal operations.
4. When there is no more boil in either pan and the fire is down to coals on the grates (in a wood fired arch), add sap until the pans are at a depth of 2”. This is done by holding the float down or by adjusting the float handles and lowering it. If the sap remaining does not cover the pans to the 2” depth then add clean, unsoftened, non-chlorinated well or spring water until the depth is reached.

NOTE: The extra sap depth is required as the insulation of the arch (ex. bricks) will hold heat and continue the evaporation process until the heat has been dissipated.

Oil Or Gas Fired

The arch can be run until the last sap to be boiled enters the flue pan float box.

1. Do a draw of sweet as referenced in the table above.
2. Monitor the evaporator until the boil stops.

MAINTENANCE

NOTES:

- Only Leader Evaporator approved chemicals are to be used in operations and maintenance.
- Ensure after use no chemical residue remains on items such as rail gaskets or pan gaskets.

Daily – prior to performing maintenance make sure the surfaces have been cooled.

1. Remove spills and splashes from the pan by wiping with hot water.
2. Follow the steps listed for Reversal of Syrup Pans
3. If using a wood fired arch, clean out the ash chamber and the slots or holes in the grates NOT the “V” grooves of the grates, if present.
4. Standard wood fired arch – brush the flues.
5. Check all fittings for leakage. Repair / replace as necessary.

Periodic

1. Wood Fired Arch - Using the supplied brush and rod, brush the underside of the flue pan to remove accumulated material. Cleaning will allow the heat to better reach the sap in the pan. For a standard wood fired arch brush daily. For an INFERNO arch brush weekly.
2. Inspect the rail gasket and pan gasket for areas where heat and smoke may be escaping. Replace if necessary.
3. If excessive niter and sugar sand is coating the surfaces of the pans with scale, clean the pans with a pan cleaner such as LEADER Order #63006 (1 quart size). It is recommended the pan be cleaned in place as follows – valves have been provided to aid in this process:
 - a. Close the butterfly valve between the hot sap box and the flue pan.
 - b. Drain the syrup pans
 - i. Open the butterfly valves in front of the draw off boxes
 - ii. Open the ball valves under the draw off boxes
 - iii. The syrup pans can be lifted, on the side opposite the draw off boxes, up to 2” to aid in draining
 - c. Close the draw off box ball valves and the butterfly valves.
 - d. Chemical clean as follows:
 - i. Add unsoftened, non-chlorinated well or spring water to the pans until the coating to be removed is covered with water.
 - ii. Add 1 quart of concentrated pan cleaner for each 40 gallons of water in the pans.
 - iii. Heat the solution to simmering and keep at that level for one hour and the scale is noted to dissolve.
 - iv. Wearing protective gear, brush the loose scale.
 - v. If scale is removed flush the pans with unsoftened, non-chlorinated well or spring water. If the scale is thick you may need to continue simmering the solution in the pan.
 - vi. When the scale has been removed, drain off the solution, fill the pans with clean unsoftened, non-chlorinated well or spring water. Add 2 pounds of baking soda to 200 gallons of clean water. Heat to a light boil, brush the pans, and empty the water from the pans.
 - vii. Open all syrup pan valves and ensure all solution is rinsed from the pans and the plumbing using unsoftened, non-chlorinated well or spring water.
 - e. Reset the valves to settings for operations.
4. If all syrup pans are to be removed (evaporator should not be heated):
 - a. Removal and replacement of the front syrup pan only
 - i. Close the butterfly valve between the hot sap box and the flue pan. Close the butterfly valves on the rear syrup pan(s).
 - ii. Open the butterfly valve in front of the draw off box on the front syrup pan.
 - iii. Open the ball valves under the draw off boxes on the front syrup pan and allow the pan to drain. The side opposite the draw off boxes can be raised up to 2” to aid in draining.

- iv. Disassemble and remove the butterfly valve from the front connection of the draw off box on the front syrup pan. Remove the heavy duty clamp and Teflon gasket from the rear connection on the front syrup pan.
- v. Remove the syrup pan.
- vi. Inspect the pan gasket for leaks. Replace if necessary.
- vii. Place the new syrup pan onto the arch in front of the installed syrup pan(s).
- viii. Line up the connection pipe and install the butterfly valve to the connection on the front draw off box of the front syrup pan.
- ix. Install the heavy duty clamp and Teflon gasket to the rear connection on the rear draw off box of the front syrup pan.
- x. Set the valves for operations.
- b. Removal and replacement of all syrup pans
 - i. Close the butterfly valve between the hot sap box and the flue pan.
 - ii. Drain the syrup pans
 - 1. Open the butterfly valves in front of the draw off boxes
 - 2. Open the ball valves under the draw off boxes
 - 3. The syrup pans can be lifted, on the side opposite the draw off boxes, up to 2" to aid in draining

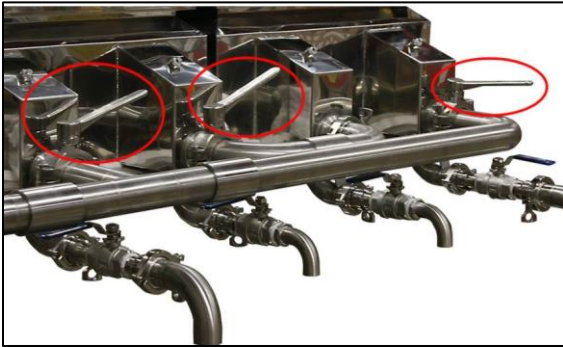

- iii. Remove the butterfly valve handles.



- iv. Remove the heavy duty clamp and Teflon gasket between the hot sap box and the connection pipe. Then slide out the end section of pipe.



- v. Remove the butterfly valve and the front section of pipe connecting the front draw off box of the front syrup pan to the connection pipe (at the tee).

- vi. Remove the butterfly valve connecting the tee to the rear draw off box of the rear syrup pan. Remove the tee.

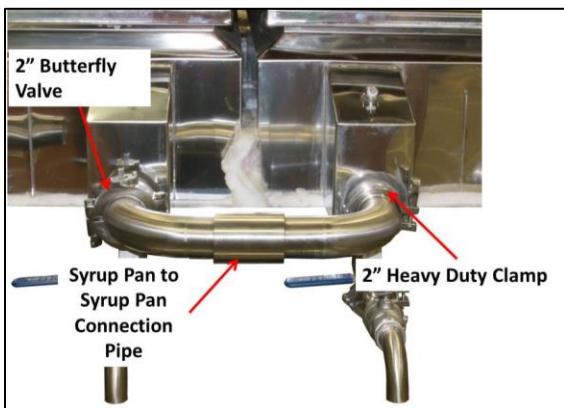

- v. Remove the butterfly valve(s) and the heavy duty clamp(s) between the syrup pan(s). Remove the syrup pan to syrup pan connection pipe(s).

- vi. Remove the pans from the arch.
- vii. Inspect the pan gaskets and replace if necessary.
- viii. Reference the Setting the Pans section of this document (page 16) for instructions on placing the pans back onto the arch.
- ix. Reference the Setting the Pans section of this document (page 16) for instructions on reconnecting the pans.
- x. Set the valves for operations.

End Of Season

NOTES:

- Do not allow sap or acid solutions to soak in the pans for more than 24 hours.
 - Use ONLY cleaners stated to be for maple syrup equipment.
 - Never store or transport the flue pan upside down.
1. Drain the flue pan by closing the sap source to the regulator box and opening the ball valve at the rear of the flue pan.
 2. Drain the syrup pans by opening the draw-off valves and the valves between the hot sap box and the syrup pan. The syrup pans can be lifted approximately 2" on the side opposite the draw off boxes to aid in the draining. Use caution so as not to break fittings.
 3. Rinse the pans with unsoftened, non chlorinated well or spring water and then drain.
 4. Close the valves on the pans.
 5. Clean the pans with a pan cleaner such as LEADER Order #63006 (1 quart size). The directions are as follows:
 - a. Add unsoftened, non-chlorinated well or spring water to the pans until the coating to be removed is covered with water.

- b. Add 1 quart of concentrated pan cleaner for each 40 gallons of water in the pans.
- c. Heat the solution to simmering and keep at that level for one hour and the scale is noted to dissolve.
- d. Wearing protective gloves, brush the loose scale.
- e. If scale is removed flush the pans with unsoftened, non-chlorinated well or spring water. If the scale is thick you may need to continue simmering the solution in the pan.
- f. When the scale has been removed, drain off the solution, fill the pans with clean unsoftened, non-chlorinated well or spring water. Add 2 pounds of baking soda to 200 gallons of clean water. Heat to a light boil, brush the pans, and empty the water from the pans.
- g. Ensure all solution is rinsed from the pans using unsoftened, non-chlorinated well or spring water.
6. Disassemble pan connections.
 - a. Disassemble the main connection pipe removing the slip fittings.
 - b. Inspect all seals, gaskets and O-rings. Replace as necessary.
 - c. Lubricate the O-rings of the slip fittings with food grade grease then place the slip fittings into sealed plastic bags.
7. Discard the rail gasket and pan gasket.
8. Inspect all arch insulating materials (brick, insulating board, blanket). Replace if missing or damaged.
9. Clean the grates.
10. Raise the flue pan out of the arch and finish draining.
11. Thoroughly brush the soot from the flues of the flue pan.
12. Set 2X4s across the rail of the arch where the flue pan is usually placed then set the flue pan right side up on the 2X4s.
13. Set 2X4s across the rail of the arch where the syrup pans are usually placed then set the syrup pans right side up on the 2X4s.
14. Cover the pans and arch with plastic, tarp or hoods.

Beginning Of Season Startup

1. Remove the cover and take the pans and 2X4s off from the arch.
2. Install a new rail gasket.
3. Place the pans on the arch and install new pan gaskets between the pans.
4. Assemble the pan connections and install the float boxes and floats.
 - a. Prior to assembling the main connection pipe, lubricate the slip fittings.
5. Wipe and/or rinse out the pans.
6. When filling the pans for the first time check all fittings for leakage and repair if necessary.

FEEDBACK

Please use the following e-mail address (feedback@leaderevaporator.com) to suggest improvements or enter comments on this document. Reference the document title in your note. You may also contact LEADER Customer Service.

NOTES

ATTACHMENT #1: HYDROMETERS

Hydrometer Function

A hydrometer works based on the density of the maple syrup. There are two scales used for hydrometers; Brix and Baume. The Brix scale indicates the percentage of sugar in the maple syrup. The Baume scale is a measure of how dense the maple syrup is related to the density of water. The correct density for maple syrup is a minimum of 66% sugar (66°Brix/35.6°Baume). You will need to verify your state's rules and adjust your readings as necessary. The hydrometers supplied by LEADER EVAPORATOR have been calibrated at two temperatures; 60°F Cold Test (66.9°Brix/36°Baume) and 211°F Hot Test (59.1°Brix/32.1°Baume). The maple syrup is expected to be at the upper temperature when it is measured immediately after being drawn off the evaporator.

NOTE: Hydrometers from Leader Evaporator by law are calibrated by the State of Vermont. The HOT and COLD test lines should be considered guidelines. Hydrometers should only be used by reading temperature and Brix/Baume readings.

Use Of A Hydrometer

NOTE: Hydrometers are very fragile. The two most susceptible points of damage during use are the bottom and where the stem meets the body. Take extreme care when handling a hydrometer.

As hydrometers are susceptible to damage it is recommended the sugar house have a spare.

Preparing A New Hydrometer For Use

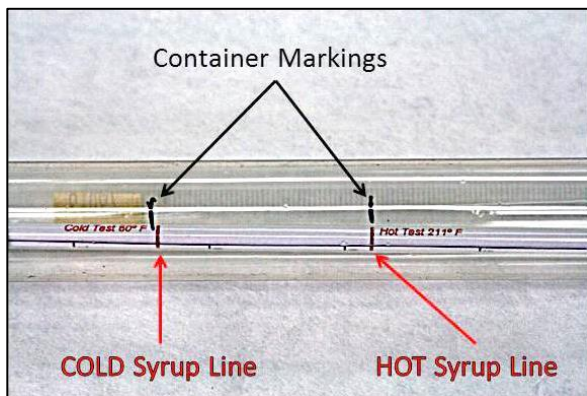

1. Unpack the hydrometer from its tube or box.
2. Carefully inspect the hydrometer for any breakage. If you suspect any cracks, fill your test cup with hot water and immerse the hydrometer. If it leaks then it is damaged and can't be used.
3. Place the hydrometer in its original container seated in the packaging and mark the container where the bottom of the hydrometer aligns.
4. Mark the container at the same lines as the HOT and COLD test lines in the hydrometer. When using the hydrometer in the future these lines are a check to ensure the scale inside the hydrometer has not moved.

Using The Hydrometer

1. Prior to using the hydrometer for the day, place it into its original container and check the hydrometer lines against the lines you marked on the container. If they do not match then replace the hydrometer.
2. Ensure the hydrometer is clean prior to every use. Accumulated material on the hydrometer will cause the hydrometer readings to be incorrect as it will have extra weight and not float as easily.
3. Hold the test cup upright. Fill the test cup up to ½" to ¾" from the top with the syrup to be tested or from the syrup compartment of the syrup pan. DO NOT HAVE THE HYDROMETER IN THE CUP.
4. Do not allow the syrup to cool. Place the cup on a level surface. Immerse a thermometer into the test cup. Slowly immerse the hydrometer into the syrup in the test cup until it reaches the "HOT" test mark then carefully release it. NEVER DROP THE HYDROMETER INTO THE TEST CUP.
5. Read the temperature from the thermometer.

6. Read the Brix or Baume number from the hydrometer.

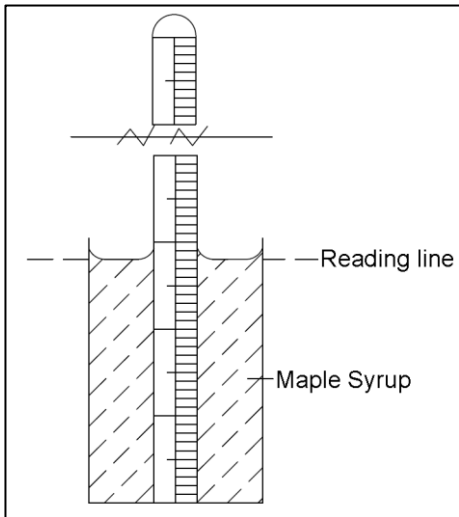

NOTE: To correctly determine the Brix/Baume, you need to read from the line of the syrup.

LEADER EVAPORATOR Hydrometers: Hydrometers from LEADER EVAPORATOR are calibrated by the State of Vermont at two temperatures; 60°F Cold Test (66.9°Brix/36°Baume) and 211°F Hot Test (59.1°Brix/32.1°Baume). After numerous measurements it was determined 211°F is the average temperature of syrup when measured immediately after draw-off from the evaporator. When checking syrup at 211°F, the syrup is at the proper concentration when the reading line is at the Hot Test line. If the Hot Test Line is below the reading line of the liquid, continue to boil as the syrup is “light”. If the Hot Test Line is above the reading line of the liquid, the syrup is “heavy” and will need to be diluted with sap.

TEMPERATURE °F	Degrees Baume	Degrees Brix
209	32.0	59.0
202	32.25	59.6
193	32.5	60.0
185	32.75	60.4
176	33.0	60.9
167	33.25	61.4
158	33.5	61.8
149	33.75	62.3
140	34.0	62.8
130	34.25	63.3
120	34.5	63.8
110	34.75	64.3
100	35.0	64.8
90	35.25	65.4
80	35.5	65.9
70	35.75	66.4
60	36.0	66.9
50	36.25	67.4

7. Refer to the chart to determine if your syrup is “light” or “heavy”. If the reading is higher than the number on the table your syrup is “heavy” and will need to be diluted. If the number is lower than the number in the table, the syrup is “light” and will need to be boiled more.

8. After reading the hydrometer, remove it from the test cup and rinse it with either hot water or hot sap to ensure it is clean. Dump the contents of the test cup into the syrup compartment of the syrup pan or back into its storage container. Rinse the test cup with hot sap or hot water.

9. During the boiling period, store the hydrometer in a container of clean hot water or hot sap.